

LANGUAGES



INSTRUCTION MANUAL



SHERO4

- Download the latest version of the manual from www.corally.com
- Téléchargez la dernière version du manuel à partir de www.corally.com
- Download the latest version of the manual from www.corally.com
- Download de nieuwste versie van de handleiding van www.corally.com



C-00287 Manual - V2

WWW.CORALLY.COM

CAUTION GUIDE • INTRODUCTION



Thank you for purchasing a Team Corally car. This manual describes the instructions for using the model and the electronic components. You will also find some tips on how to maintain your RC model so that you can enjoy it for years to come. You have purchased one of the most efficient models available on the market that has been designed by a team of professionals. You will also benefit from the best after-sales support. All Team Corally models guarantee a high quality of manufacture and performance that guarantees you a high satisfaction of use and services provided by the Team Corally. Always take the time to read the instructions carefully in order to follow all the procedures to use your RC model safely for you and for other people and property in the area. This will allow you to take full advantage of all the performance of your RC model.

Please also check the website www.corally.com/Downloads/ to check if you have the latest version of this instruction manual. (Version: see bottom cover of this manual)

If you have any questions about the model and its components, you can send a message to info@corally.com

We also recommend that you get help from an experienced model maker or your dealer.

You will find all the references of the spare parts on the website www.corally.com

TERM OF USE

The user is responsible for the use of your model. The user assumes all risks associated with the use of the model. This model is not intended for use by children under 14 years of age without the supervision of a responsible adult who is familiar with the dangers of using a RC model. Team Corally / JSP Group Intl bvba, its manufacturers, distributors and resellers cannot control the use and load of the model and therefore cannot be held responsible for any damage to property and damage caused to persons resulting from the use of this product. You must accept these conditions and consider yourself fully responsible for the use of this product. If not, do not use this product.

Due to the continuous development of our products, the exact specifications of the kit may vary. If you have a problem with your new kit, please contact the store where you purchased it, indicating the part number(s).

Team Corally / JSP Group Intl bvba reserves the right to change any specification without notice. All rights reserved.

CAUTION GUIDE • READ FIRST

This owner's manual is designed for use with your vehicle and contains the instructions you will need to operate and maintain your vehicle.

- We know you want to start driving immediately after unpacking, but it is very important that you take the time to read this manual carefully, even if you are an experienced R/C driver.
- Read carefully and follow all instructions in this manual. Failure to comply with the instructions will be considered as abuse and/or negligence which may result in the cancellation of the warranty.
- Your vehicle is designed to operate on uneven terrain. However, dust, sand, water and carpet fibres can get into your car's work-spaces and can damage your vehicle if they are not removed quickly. We do not guarantee any warranty on your vehicle against damage caused by external elements such as sand, dirt or water. Users are responsible for the maintenance and safe operation of this vehicle.
- This product is not a toy. It is not suitable for users under 14 years of age, unless they are supervised by adults.
- Never attempt to disassemble electronic components. These have been carefully calibrated at the factory.
- Only improve your car with parts made for your car. If you upgrade performance, replace the entire system (such as the motor, inverter, battery, etc.) so that all components are properly adapted. Any malfunction resulting from a custom modification will void your warranty.
- Before driving your vehicle, please read this manual in its entirety and examine your vehicle and radio control system for any defects.
- For better performance, some adjustments may be necessary.
- This vehicle requires a battery (included in the car or in the packaging). Make sure the vehicle's battery is sufficiently charged before driving, otherwise you may lose control of the vehicle.
- The radio transmitter requires 4 AA batteries (not included)
- Always remove or disconnect the battery from the vehicle to the inverter when not in use.
- Please drive your car in a spacious place. Never drive your car on the street or in traffic. Public places are subject to specific legislation by country, city, municipality, please comply with the legislation for the use of RC models in your region.
- This product is fully assembled in the factory. We accept no liability for damage and/or accidents resulting from custom modifications and/or malfunctions.

CAUTION GUIDE • SAFETY PRECAUTIONS

For your safety, always use wear gloves and goggles when assembling and maintaining your model.

Always take all necessary precautions when handling products (silicone oil, grease, thread lock, cyanolyte glue, fuel) for the operation of the model. (Refer to the manufacturer's instructions)

For your safety, to keep the warranty and obtain the best performance, always use original CORALLY genuine parts.

Contains: LEAD (CAS 7439-92-1) ANTIMONY (CAS 7440-36-0)

WARNING: This product contains a chemical known to the state of California to cause cancer and birth defects or other reproductive harm.

CAUTION: CANCER HAZARD

Contains lead, a listed carcinogen. Lead is harmful if ingested. Wash thoroughly after using.

DO NOT use product while eating, drinking or smoking.

CAUTION GUIDE • OPERATION



Failure to operate your model in a safe and responsible manner may result in injury to yourself, others or damage to property around you.

- Do not use your model on public roads or in areas where you may encounter pedestrians or riders.
- Do not operate in a congested area or in crowds.
- Do not operate in areas where loud noises can disturb others, such as hospitals and residential areas.
- Do not operate your model with obstructed line of sight, at night or near water.
- Your model is radio controlled, it is subject to possible radio interference. Radio interference can cause loss of control of your model. Be careful.
- Take care not to injure yourself while using tools to adjust or upgrade your model.
- Since the model contains small parts, keep out of reach of children while assembling and/or disassembling your model.
- If your model becomes stuck against an object, release the throttle and retrieve it by hand
- Do not continue to apply the throttle when your model is stuck. This may damage the motor and/or ESC/ Receiver unit.
- Turn OFF your model and don't use it if it runs erratically. Please do not use your model again until the problem has been solved.
- Keep the wheels of the model off the ground when checking the operation of the radio equipment.
- When learning to operate your model, go to an area that has no obstacles that can damage your model.
- Before and after each use, check all the screws on the model.
- To maintain the best performance, check that all moving parts move freely.



Take all necessary precautions before, during and after using your model. You are responsible for the safe assembly, maintenance and use of your model.

In case of any questions, contact your local reseller or contact Team Corally support for assistance.

CAUTION GUIDE • LIPO BATTERY

- Follow and respect the manufacturer's instructions for use
- It is important to check that your ESC is set to LIPO if you are using a LIPO battery. Failure to comply with this instruction will result in increased battery discharge and may cause fire and damage to persons and property.
- When charging or storing LiPo batteries always use LiPo Safety Bag (Flame retardant).
- Always respect the maximum rate and voltage specified by the battery manufacturer.
- Charge the LIPO battery outdoors or in a ventilated area away from flammable objects and surfaces.
- NEVER leave your LiPo battery unattended while charging.
- If the battery swells during charging, stop charging immediately and disconnect the battery from the charger. Leave the battery outside for a few hours and observe. Then recycle the battery according to the instructions of your country/region. Never dispose of a LIPO battery with domestic waste.
- Before recycling your defective battery, it must be neutralized. Take a plastic container, fill it with water and add a lot of salt until the water becomes opaque. Place the LIPO battery in the water and leave for 24 hours. Check with a voltmeter that the voltage is 0.0V. Then recycle the battery according to local regulations.
- Never charge a damaged or inflated battery.
- Never discharge the battery cells below 3.2V.
- Always use the appropriate balancer/charger when charging your LiPo battery pack.
- When the battery is empty, check the temperature of the battery before charging it. If the battery is very hot, wait until it cools before charging it.
- Never charge a very hot battery as this may cause an explosion or fire.
- When the battery is empty, recharge it immediately. Do not store an empty battery, the battery will continue to discharge, it will fall below the minimum voltage and become unusable.

WARRANTY • QUICK START GUIDE



If material defects or manufacturing faults should arise in a product distributed or manufactured by Team Corally / JSP Group Intl bvba, and purchased by a consumer, we Team Corally / JSP Group Intl bvba acknowledge the obligation to correct those faults or defects within the limitations described below. This manufacturer's warranty is in addition to, and does not affect, the legal or contractual rights of the consumer which arise from the purchase of such products. Team Corally / JSP Group Intl bvba guarantees the consumer that its products are free from material, manufacturing, and construction faults, as determined by the general state of knowledge and technology valid at the time of manufacturing. The fault responsible for causing the damage must be proven to have been present in the product at this time. Claims for compensation arising from consequential damage or product liability will not be considered valid unless they fall under peremptory provisions of the law. If material defects or manufacturing faults should arise in a product distributed or manufactured by Team Corally / JSP Group Intl bvba in the European community (EC) and purchased by a consumer, then Team Corally / JSP Group Intl bvba undertakes to correct those defects within the limitations described below. This manufacturer's declaration does not affect the consumer's legal or contractual rights regarding defects arising from the purchase contract between the consumer and the dealer or reseller. **Extend of the Warranty**

If a claim is made under warranty, we take at our discretion to repair or replace the defective goods. We will not consider supplementary claims, especially for reimbursement of costs relating to the defect (e.g. installation / removal costs) and compensation for consequent damages unless they are allowed by statute. This does not affect claims on legal regulations, especially according to the product liability law.

Provisions of the Warranty

The purchaser is required to make the warranty claim in writing, and must enclose original proof of purchase (e.g. invoice, receipt, delivery note) and the appropriate warranty card. He must send the defective goods to our local representatives or directly to Team Corally / JSP Group Intl bvba, Geelseweg 80, 2250 Olen, Belgium at his own risk and cost.

The purchaser should state the material defect or manufacturing fault, or symptoms of the fault, as accurate as possible, so that we can check if our warranty obligation is applicable. The goods are transported from the consumer to us, and from us to the consumer, entirely at the risk and cost of the consumer.

Invalidation of the Warranty

The consumer cannot make a claim under warranty when the fault is affecting the use of the product arising from natural wear, competition use, or improper use (including installation) or external forces. The consumer's adherence to the building and operating instructions relevant to the model, including the installation, operation, use of, and maintenance of, model-related components cannot be supervised by Team Corally / JSP Group Intl bvba. Therefore Team Corally / JSP Group Intl bvba is in no way liable for loss, damage, or costs resulting from improper use, or behaviour in any way connected to the above described provisions. Unless otherwise required by law, Team Corally / JSP Group Intl bvba is in no way whatever liable to provide compensation for damages arising from the improper use of the model (including personal injury, death, damage to buildings, loss of turnover, loss of business, or interruption of business, or any other direct, or indirectly caused, consequential damage).

Duration of Validity

The claim period is 24 months from the date of purchase of the product by the consumer from a dealer in the European Community (EC) counted from the date of purchase. The claim period is 12 months from the date of purchase of the product by the consumer from a dealer outside the European Community (EC) counted from the date of purchase. If a defect arises after the end of the claim period, or if evidence or documents required according to this declaration in order to make the claim valid are not presented until after this period, then the consumer forfeits any rights or claims from this declaration. The guarantee period is not prolonged by the granting of any claims within the framework of this warranty, especially in the case of repair or replacement. The guarantee period also does not restart in such cases.

Warranty Expiration

If we do not acknowledge the validity of a claim based on this declaration within the claim period, all claims based on this declaration will expire after six months from the time of registering the claim; however this cannot occur prior to the end of the claim period.

For any support, contact us at support.corally.com

DOWNLOAD • QUICK START GUIDE



Download the latest version of this manual and other languages.
 Download other instruction manuals about : **Electronics - LiPo Safety Instructions - Spare parts - Option Parts ...**

<https://corally.com/en/useful-links/downloads-manuals>

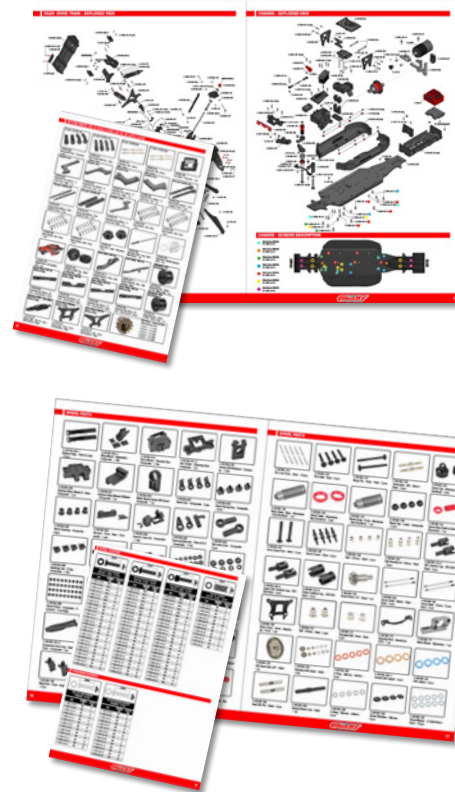
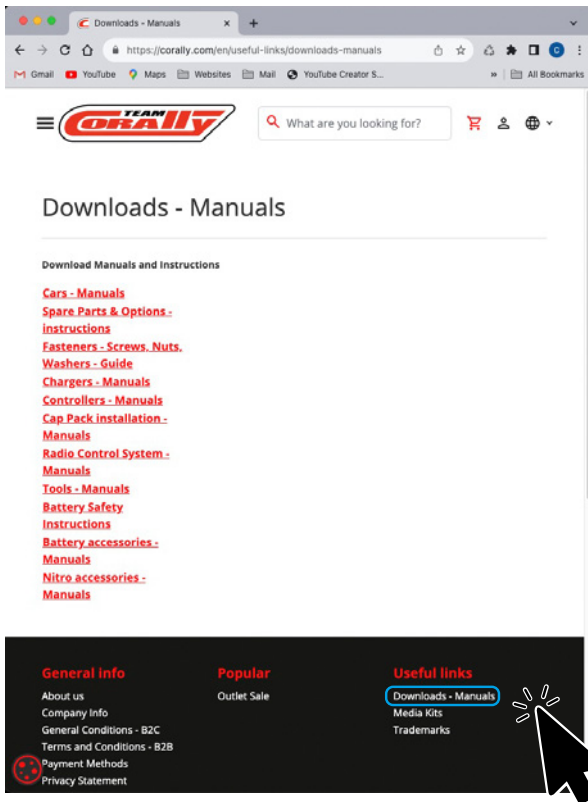

KIT CONTENT



Transmitter



RTR Model



User Guide

REQUIRED FOR OPERATION (Not included)

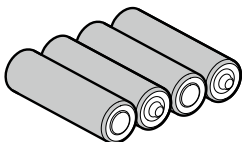

4x AA Batteries for the Transmitter

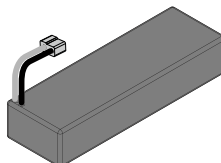

Li-Po battery Minimum capacity of 4000mAh - 30C discharge rate.
 #C-49231-X Lipo Battery - 5000mAh - 3S 11.1V
 #C-49232-X Lipo Battery - 5000mAh - 4S 14.8V

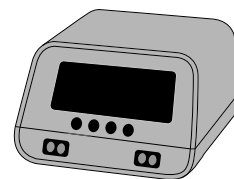

3S/4S LiPo Charger

Hex Drivers

1.5mm • 2.0mm • 2.5mm • 3.0mm

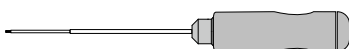

Nut Drivers

5.5mm • 7.0mm

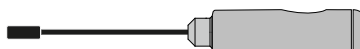

Silicone Oil & Grease (for maintenance)

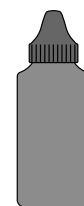

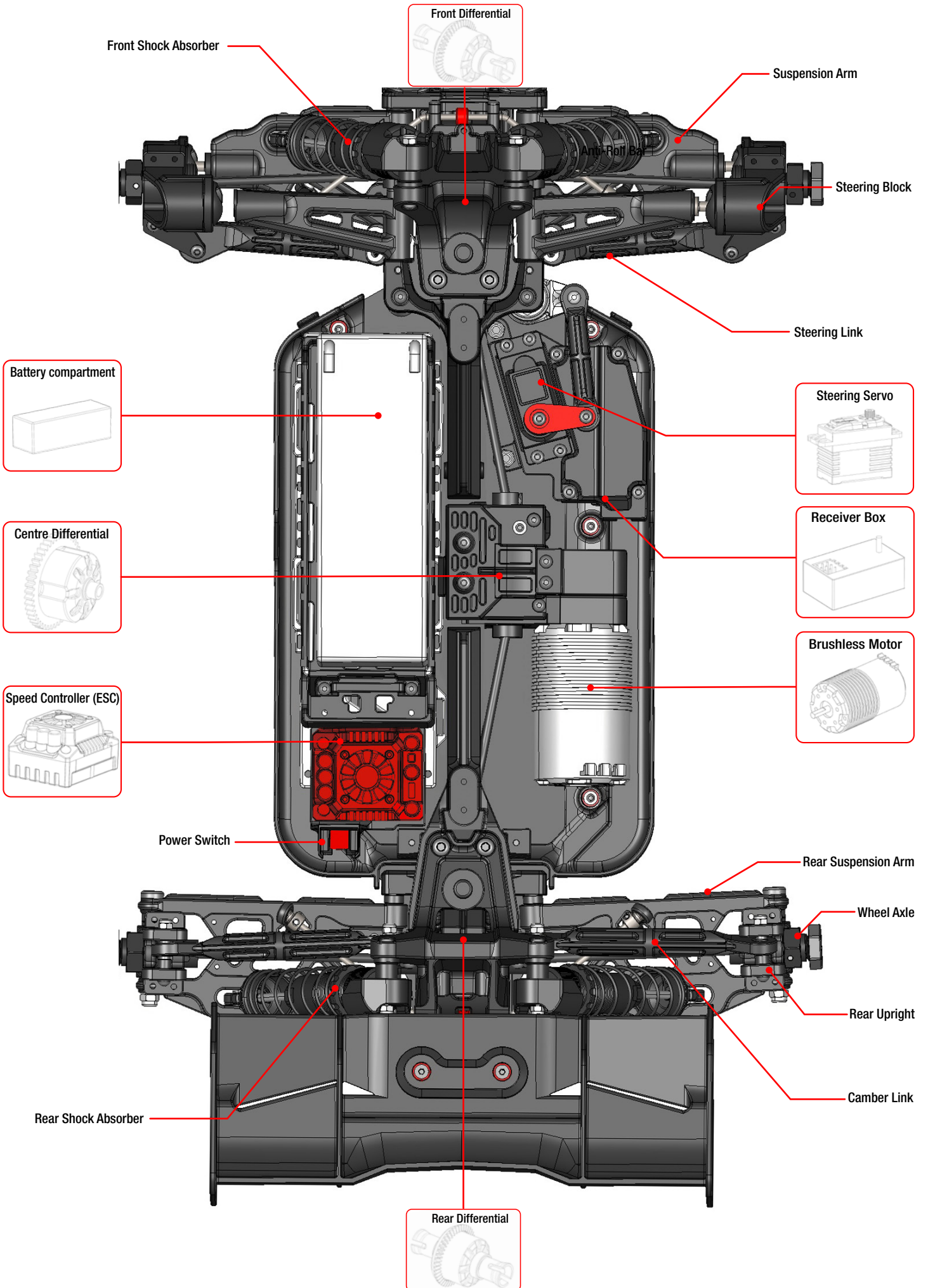



READ THE INSTRUCTIONS



- Lisez les instructions
- Lesen Sie die Anleitung
- Lees de instructies

CHARGE THE BATTERY

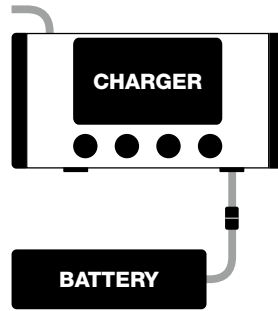

- Chargez la batterie
- Laden Sie den Akku
- De batterij opladen

INSTALL 4x AA BATTERY - 1.5V

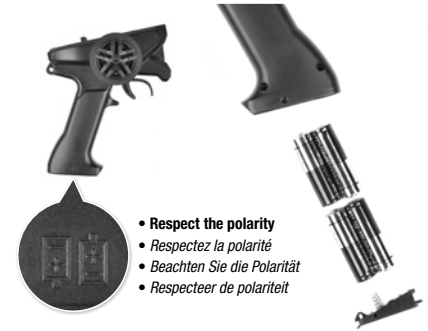

- Installez les piles dans l'émetteur
- Setzen Sie die Batterien in den Sender ein
- Plaats de batterijen in de zender

MAKE SURE THAT ALL SCREWS AND NUTS ARE TIGHTENED PROPERLY.

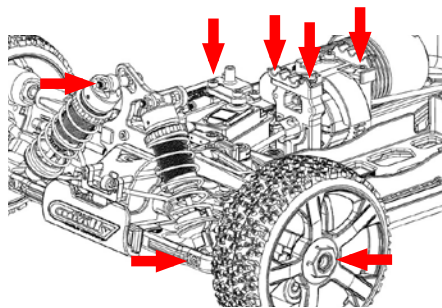

- Vérifiez le serrage des vis et écrous
- Überprüfen Sie die Schrauben und Muttern auf festen Sitz
- Controleer de vastheid van de schroeven en moeren

INSTALL THE FULLY CHARGED BATTERY

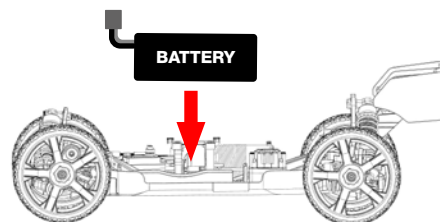

- Installez la batterie chargée
- Setzen Sie den geladenen Akku ein
- Installeer de opgeladen batterij

TURN ON THE TRANSMITTER (Always First)



- Allumez l'émetteur (Toujours en premier)
- Schalten Sie den Sender ein (Immer zuerst)
- Zet de zender aan (altijd eerst)

CONNECT THE BATTERY TO THE ESC SWITCH ON THE ESC

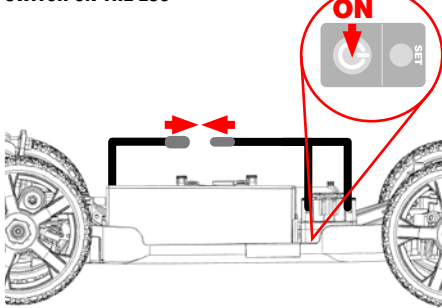

- Connectez la batterie au variateur et allumez-le
- Schließen Sie den Akku an den Regler an und schalten Sie ihn ein
- Sluit de accu aan op de regelaar en schakel deze in

CHECK THE FUNCTIONS

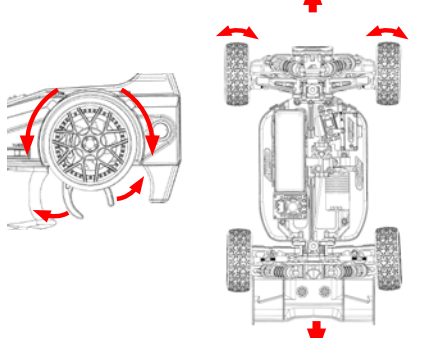

- Contrôlez les fonctions
- Kontrollieren Sie die Funktionen
- Controle van de functies

CHECK THE RADIO SYSTEM RANGE

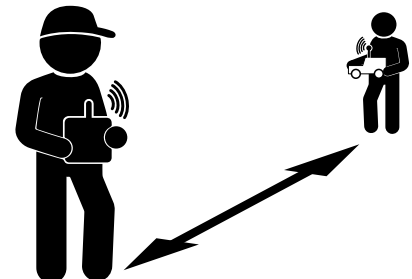

Move away from the max. distance you will drive the vehicle. Check that the vehicle responds properly to the controls. If not, reduce the distance or change the driving location.

- Contrôlez la portée de l'émetteur
- Überprüfen Sie die Reichweite des Senders
- Controleer het bereik van de zender

DRIVE SLOWLY TO BEGIN

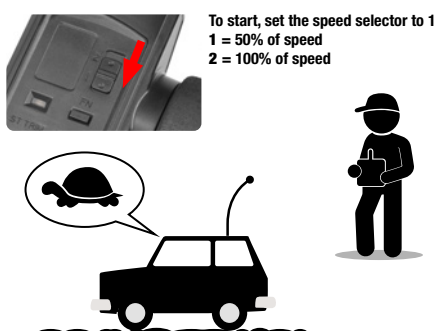

To start, set the speed selector to 1
1 = 50% of speed
2 = 100% of speed

- Pour débuter placez le sélecteur de vitesse sur 1
- Um zu beginnen, stellen Sie den Geschwindigkeitswahlschalter auf 1
- Zet om te beginnen de snelheidskeuzeknop op 1

WHEN FINISHING

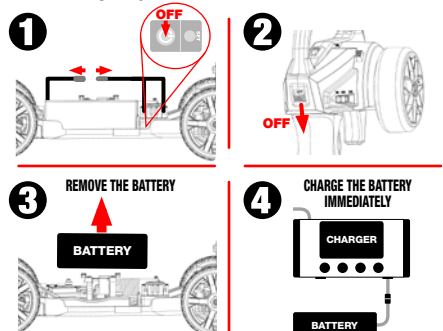

- Après, débranchez la batterie et rechargez-la immédiatement.
- Trennen Sie den Akku ab und laden Sie ihn sofort wieder auf.
- Ontkoppel dan de batterij en laad deze onmiddellijk op.

CLEAN AND MAINTAIN YOUR VEHICLE



- Nettoyez et entretenez votre voiture !
- Reinigen und pflegen Sie Ihr Auto!
- Reinig en onderhoud uw auto!

SPEED GEAR CHART - TABLEAU DES VITESSES - DREHZAHLGANGDIAGRAMM - VERSNELLINGSTABEL

GEAR RATIO : 3.31
 SPUR GEAR : 46T
 MOTOR KV : 2150
 TYRE Ø mm : 115

	Km/h	Mph	Km/h	Mph	Km/h	Mph
Gear	13T Pinion		15T Pinion		17T Pinion	
46T	11,71		10,14		8,95	
3S	48	30	55	34	62	39
4S	64	40	73	45	83	52

■ Factory fitted

■ OK

■ Usable but not recommended



Note: The speed indicated in the table is a theoretical speed for information purposes. The real speed varies according to the type of terrain, electronic equipment, atmospheric conditions and other driving parameters.

Note: La vitesse indiquée dans le tableau est une vitesse théorique à titre indicatif. La vitesse réelle varie en fonction du type de terrain, de l'équipement électronique, des conditions atmosphériques et d'autres paramètres de conduite.

Bemerkung: Die in der Tabelle angegebene Geschwindigkeit ist eine theoretische Geschwindigkeit, die nur als Referenz dient. Die tatsächliche Geschwindigkeit hängt von der Art des Geländes, der elektronischen Ausrüstung, den Wetterbedingungen und anderen Fahrparametern ab.

Nota: De in de tabel aangegeven snelheid is een theoretische snelheid, uitsluitend ter referentie. De werkelijke snelheid varieert afhankelijk van het soort terrein, de elektronische apparatuur, de weersomstandigheden en andere rijparameters.

MOTOR PINION MOD1.0 - PIGNON MOTEUR MOD1.0 - MOTORRITZEL MOD1.0 - MOTOR PINION MOD1.0

- You can choose a different pinion size to change the speed or acceleration. The car is equipped with a 13-tooth pinion from the factory, which is the best ratio of power to speed and battery life. Adapt the pinion to the type of terrain (off-road = small pinion, speed = large pinion). If the motor gets too hot or the controller shuts down (safety), the motor makes too much effort, reduce the pinion size.
- Vous pouvez choisir un pignon de taille différente pour modifier la vitesse ou l'accélération. La voiture est équipée du pignon 13 dents en usine ce qui est le meilleur rapport puissance/vitesse et autonomie. Adaptez le pignon en fonction du type de terrain (tout-terrain = petit pignon, vitesse = grand pignon). Si le moteur chauffe trop ou le variateur se coupe (sécurité), le moteur fait trop d'effort, réduisez la taille du pignon.
- Sie können ein Ritzel unterschiedlicher Größe wählen, um die Geschwindigkeit oder die Beschleunigung zu verändern. Das Auto ist ab Werk mit einem Ritzel mit 13 Zähnen ausgestattet, was das beste Verhältnis von Leistung/Geschwindigkeit und Reichweite darstellt. Passen Sie das Ritzel an den jeweiligen Geländetyp an (Gelände = kleines Ritzel, Geschwindigkeit = großes Ritzel). Wenn der Motor zu heiß wird oder der Regler sich abschaltet (Sicherheit), der Motor zu viel Kraft aufbringt, reduzieren Sie die Größe des Ritzels.
- U kunt een andere tandwielmaat kiezen om de snelheid of versnelling te veranderen. De auto is in de fabriek uitgerust met een 13-tands tandwiel, de beste verhouding tussen vermogen, snelheid en bereik. Pas het tandwiel aan het soort terrein aan (off-road = klein tandwiel, snelheid = groot tandwiel). Als de motor te heet wordt of de regelaar uitschakelt (veiligheid), levert de motor te veel inspanning, verklein dan het tandwiel.

M1.0 PINION - HARDENED STEEL - FOR 5MM DIAMETER MOTOR SHAFT

C-72713 - Pinion 13 Teeth

C-72715 - Pinion 15 Teeth

C-72717 - Pinion 17 Teeth

- High-performance pinions gear, manufactured from special steel for toughness and durability with precise tolerances and assures unparalleled concentricity and vibration-free operation. Each pinion is marked with the tooth number for easy and quick identification. Fits all cars with MOD1 gears (1/8 Scale)
- Pignons Haute Performance, fabriqué en acier spécial avec des tolérances précises pour garantir solidité, longévité et concentricité et fonctionnement sans vibrations. Chaque pignon est marqué du nombre de dents pour une identification facile et rapide. Convient à toutes les voitures avec une transmission MOD1 (Echelle 1/8)
- Hochleistungsritzel, hergestellt aus Spezialstahl mit präzisen Toleranzen, um Festigkeit, Langlebigkeit und Rundlauf sowie einen vibrationsfreien Betrieb zu gewährleisten. Jedes Ritzel ist mit der Anzahl der Zähne gekennzeichnet, damit es schnell und einfach identifiziert werden kann. Passend für alle Fahrzeuge mit MOD1-Getriebe (Maßstab 1/8)
- Tandwielen met hoge performance, geproduceerd van speciaal staal met nauwkeurige toleranties om sterkte, duurzaamheid, concentriciteit en trillingsvrije werking te garanderen. Elk tandwiel is gemarkeerd met het aantal tanden voor snelle en eenvoudige identificatie. Past op alle auto's met MOD1-transmissie (schaal 1/8)







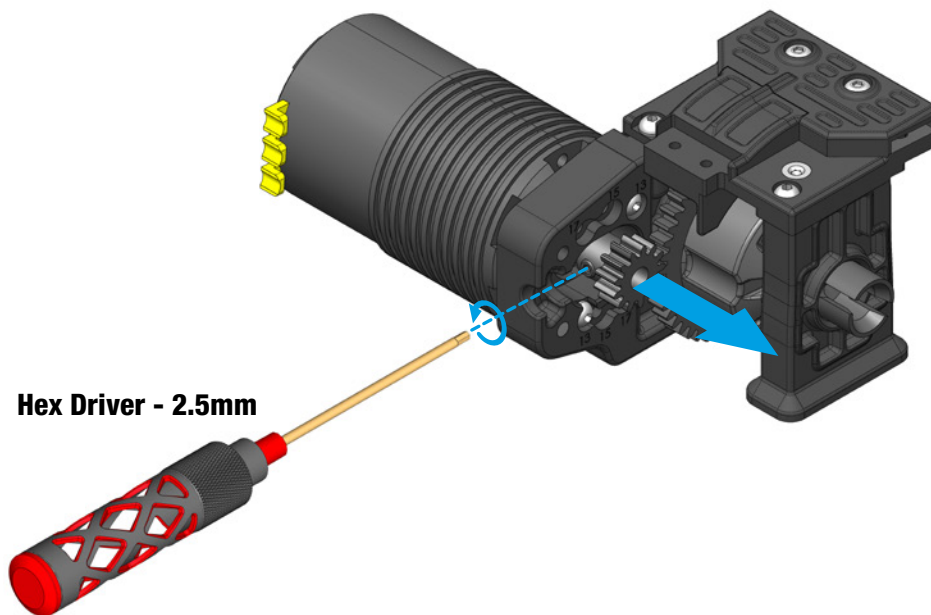

CHANGING THE MOTOR PINION - CHANGEMENT DU PIGNON MOTEUR - AUSWECHSELN DES MOTORRITZELS - VERANDEREN VAN HET MOTORRONDSEL

- You can change the transmission ratio by changing the motor pinion. You can choose from 3 sprocket sizes 13, 15 and 17 teeth. The 13-tooth pinion is factory fitted and allows you to ride on all types of rough terrain. The 15-tooth will allow you to drive a little faster on any terrain and the 17-tooth will make the car go even faster but be careful not to use it on very rough terrain with steep climbs, mud or high grass as the engine will make a lot of effort, risk to get hot and will consume more battery.
- Vous pouvez modifier le rapport de transmission en changeant le pignon moteur. Vous avez le choix de 3 tailles de pignon 13, 15 et 17 dents. Le pignon 13 dents est installé d'usine et permet de rouler sur tout type de terrain accidenté. Le 15 dents permet de rouler un peu plus vite en tout terrain et le 17 dents fera rouler la voiture encore plus vite mais attention à ne pas l'utiliser sur des terrains très accidentés avec de fortes montées, de la boue ou de l'herbe haute car le moteur fera beaucoup d'effort, risque de chauffer et consommera plus de batterie.
- Sie können das Übersetzungsverhältnis ändern, indem Sie das Motorritzel austauschen. Sie haben die Wahl zwischen drei Ritzelgrößen mit 13, 15 und 17 Zähnen. Das Ritzel mit 13 Zähnen ist ab Werk eingebaut und ermöglicht das Fahren auf allen Arten von unebenem Gelände. Das 15-Zahnrad ermöglicht es Ihnen, im Gelände etwas schneller zu fahren, und das 17-Zahnrad lässt Ihr Auto noch schneller fahren, aber achten Sie darauf, es nicht auf sehr unebenem Gelände mit starken Steigungen, Schlamm oder hohem Gras zu verwenden, da der Motor dann viel Kraft aufwenden muss, heiß laufen kann und mehr Batterie verbraucht.
- U kunt de overbrengingsverhouding veranderen door het motortandwiel te veranderen. U kunt kiezen uit 3 tandwielmaten 13, 15 en 17 tanden. Het 13-tands tandwiel is in de fabriek gemonteerd en maakt het mogelijk om op alle soorten ruw terrein te rijden. Met de 15-tands kunt u iets sneller rijden op elk terrein en met de 17-tands gaat de auto nog sneller, maar pas op dat u deze niet gebruikt op zeer ruw terrein met steile hellingen, modder of hoog gras, omdat de motor dan veel moeite doet, het risico loopt heet te worden en meer accu verbruikt.



Hex Driver - 2.5mm

- Motor mounting holes according to pinion size.
- Trous de fixation moteur en fonction de la taille du pignon.
- Befestigungslöcher des Motors je nach Größe des Ritzels.
- Motorbevestigingsgaten volgens rondselgrootte

-  
Pinion - 13 Teeth - Shaft Dia. 5mm
#C-72713
-  
Pinion - 15 Teeth - Shaft Dia. 5mm
#C-72715
-  
Pinion - 17 Teeth - Shaft Dia. 5mm
#C-72717

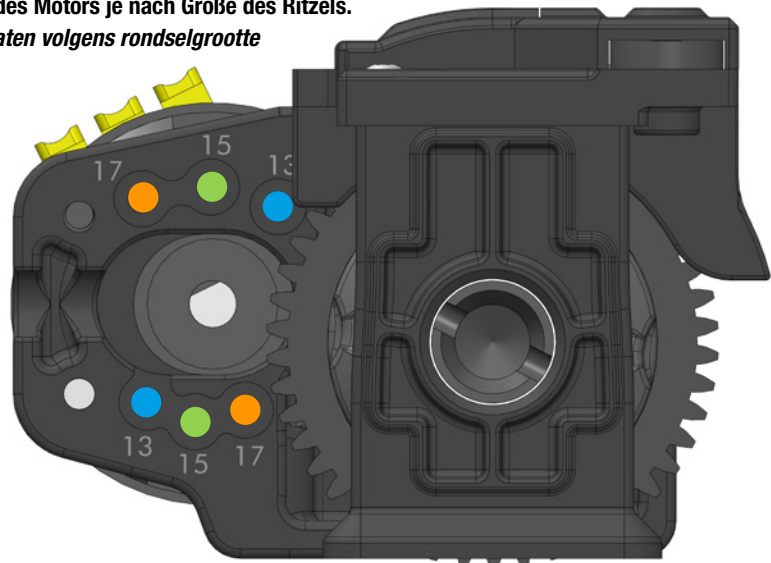



SHOCK ABSORBER MAINTENANCE - ENTRETIEN DES AMORTISSEURS - STOSSDÄMPFERWARTUNG - ONDERHOUD SCHOKDEMPERS

- It may be necessary to replace the silicone oil in the shock absorbers every 40 runs (depends on how you drive and the type of terrain you drive on).
- Il peut être nécessaire de remplacer l'huile silicone des amortisseurs toutes les 40 courses (cela dépend de votre conduite et du type de terrain sur lequel vous roulez).
- Es kann notwendig sein, das Silikonöl in den Stoßdämpfern alle 40 Fahrten zu wechseln (abhängig von Ihrer Fahrweise und dem Gelände, auf dem Sie fahren).
- Het kan nodig zijn de siliconenolie in de schokdempers om de 40 ritten te vervangen (afhankelijk van uw rijstijl en het soort terrein waarop u rijdt).

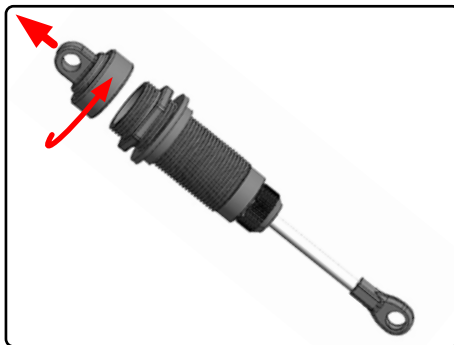
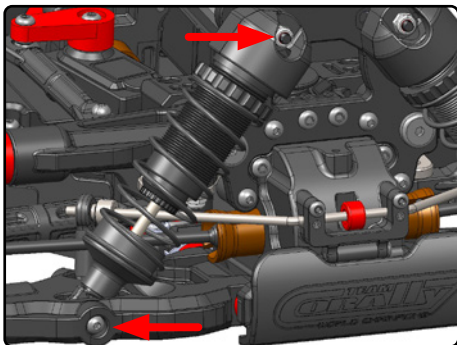

ALWAYS USE SILICONE OIL, NEVER USE ANY OTHER TYPES OF OIL • Toujours utiliser de l'huile de silicone pure, jamais d'autres types d'huile • Verwenden Sie immer Silikonöl, niemals andere Öle • Gebruik altijd siliconenolie, gebruik nooit andere soorten olie

FILL	MOVE UP	WAIT	TIGHTEN 50%	MOVE UP	TIGHTEN FULLY
<ul style="list-style-type: none"> • Fill the shock with silicone oil. • Remplissez l'amortisseur avec de l'huile de silicone. • Füllen Sie den Dämpfer mit Silikonöl. • Vul de schokdemper met siliconenolie. 	<ul style="list-style-type: none"> • Move the piston up&down (3-4x) to release the air bubbles in the silicone oil. • Déplacez le piston de haut en bas (3-4x) pour libérer les bulles d'air. • Bewegen Sie den Kolben nach oben&unten (3-4x), um die Luftblasen abzulassen. • Beweeg de zuiger op en neer (3-4x) om de luchtbelen te laten ontsnappen. 	<ul style="list-style-type: none"> • Pull the Shock shaft down and wait until the bubbles rise to the surface. • Tirez la tige d'amortisseur vers le bas et attendez que les bulles remontent à la surface. • Ziehen Sie die Schockwelle nach unten und warten Sie, bis die Blasen an die Oberfläche steigen. • Trek de Schokas naar beneden en wacht tot de luchtbelen naar de oppervlakte stijgen. 	<ul style="list-style-type: none"> • Screw in the shock absorber cap at 50%. • Vissez le bouchon d'amortisseur à 50% • Schrauben Sie die Stoßdämpferkappe zu 50 % ein. • Schroef de dop van de schokdemper op 50%. 	<ul style="list-style-type: none"> • Gently move the piston in upper position, the oil excess will flow out. • Déplacez doucement le piston en position haute, l'excédent d'huile s'écoulera. • Bewegen Sie den Kolben vorsichtig in die obere Position, das überschüssige Öl fließt dann heraus. • Beweeg de piston langzaam in de bovenste positie, de overtollige olie zal eruit stromen. 	<ul style="list-style-type: none"> • Now tighten the cap fully but not too much otherwise the membrane will be deformed. • Maintenant, serrez le bouchon à fond, mais pas trop, sinon la membrane sera déformée. • Ziehen Sie nun die Kappe vollständig, aber nicht zu fest an, da sonst die Membran verformt wird. • Draai nu de dop helemaal vast, maar niet te vast, anders wordt het membraan vervormd.

	FRONT		REAR		SHOCK PISTON
	SILICONE OIL	SPRING TENSION	SILICONE OIL	SPRING TENSION	
TRACK USE	450CPS	4mm	400CPS	0mm	4 Holes
OFF-ROAD	600CPS	4mm	500CPS	0mm	4 Holes
FACTORY	500CPS		500CPS		4 Holes



SHOCK ABSORBER - AMORTISSEUR - STOSSDÄMPFER - SCHOKDEMPER

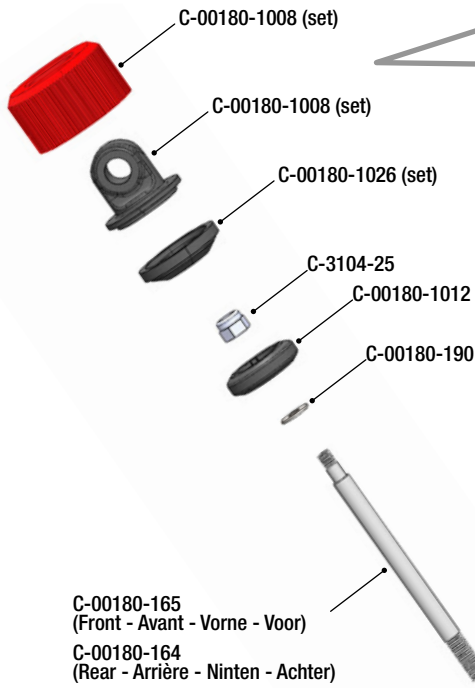

- Do not overtighten the Shock Cap to prevent deformation of the silicone Shock Bladder.
- Ne serrez pas trop le capuchon de l'amortisseur pour éviter la déformation de la membrane en silicone.
- Ziehen Sie die Dämpferabdeckung nicht zu fest an, um eine Verformung der Silikonmembran zu vermeiden.
- Draai de schokkap niet te strak aan om vervorming van het siliconenmembraan te voorkomen.

- Place all small parts on a screwdriver (Ø3mm) and push them into the shock body. All parts will be properly aligned.
- Placez toutes les petites pièces sur un tournevis (Ø3mm) et poussez-les dans le corps de l'amortisseur. Toutes les pièces seront correctement alignées.
- Setzen Sie alle Kleinteile auf einen Schraubendreher (Ø3mm) und drücken Sie sie in den Dämpferkörper. Alle Teile werden richtig ausgerichtet.
- Plaats alle kleine onderdelen op een schroevendraaier (Ø3mm) en duw ze in de behuizing van de schokdemper. Alle onderdelen zullen goed uitgelijnd zijn.

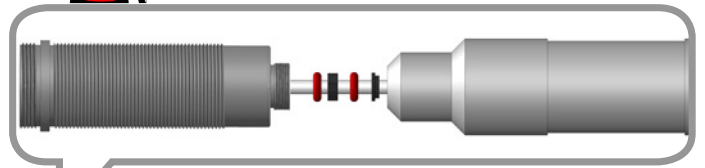

C-00180-1025 (set)

APPLY SILICONE OIL

- Appliquez de l'huile silicone
- Silikonöl auftragen
- Breng siliconenolie aan

OPTION

Aluminium Hard Anodised

C-00180-135-1
Shock Absorber "Ready Build" -
600 Cps Silicone Oil - FRONT

C-00180-137-1
Shock Absorber "Ready Build" -
600 Cps Silicone Oil - REAR

C-00180-1026 (set)

C-00180-1025 (set)
C-00180-1026 (set)

C-00180-1025 (set)

C-00180-627 - Medium (Front - Avant - Vorne - Voor)
C-00180-290 - Medium (Rear - Arrière - Ninten - Achter)

Shock Spring Cup with locking system

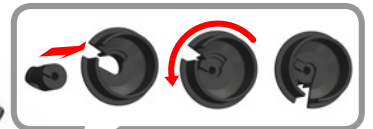

C-00180-029

C-00180-770 (Short)

C-00180-149



- Spring tension: Adjust the rebound and ground clearance by turning the shock spring tension ring.
- Tension du ressort : Ajustez le rebond et la hauteur de garde au sol en tournant la bague de tension du ressort d'amortisseur.
- Federspannung: Stellen Sie den Rückprall und die Höhe der Bodenfremheit ein, indem Sie den Spannungsring der Stoßdämpferfeder drehen.
- Veerspanning: Stel de terugvering en bodenvrijheid in door aan de veerspanningsring van de schokdemper te draaien.



DIFFERENTIAL MAINTENANCE - ENTRETIEN DU DIFFÉRENTIEL - DIFFERENZIALWARTUNG - DIFFERENTIEEL ONDERHOUD

- It may be necessary to replace the silicone oil every 50 runs (depends on how you drive and the type of terrain you drive on). To dismount and maintain the differentials, follow the steps on these pages. To reassemble the differentials, repeat the steps in reverse.
- Il peut être nécessaire de remplacer l'huile silicone toutes les 50 courses (cela dépend de votre conduite et du type de terrain sur lequel vous roulez). Pour démonter et entretenir les différentiels, suivez les étapes sur ces pages. Pour remonter les différentiels, répétez les étapes en sens inverse.
- Es kann notwendig sein, das Silikonöl alle 50 Fahrten zu wechseln (abhängig von Ihrer Fahrweise und dem Gelände, auf dem Sie fahren). Um die Differentiale zu zerlegen und zu warten, befolgen Sie die Schritte auf diesen Seiten. Um die Differenziale wieder zusammenzusetzen, wiederholen Sie die Schritte in umgekehrter Reihenfolge.
- Het kan nodig zijn de siliconenolie om de 50 ritten te vervangen (afhankelijk van uw rijstijl en het soort terrein waarop u rijdt). Volg de stappen op deze pagina's om de differentiëlen te verwijderen en te onderhouden. Om de differentiëlen weer in elkaar te zetten, herhaalt u de stappen in omgekeerde volgorde.

FRONT DIFFERENTIAL - DIFFÉRENTIEL AVANT - VORDERACHSDIFFERENTIAL - VOORSTE DIFFERENTIEEL

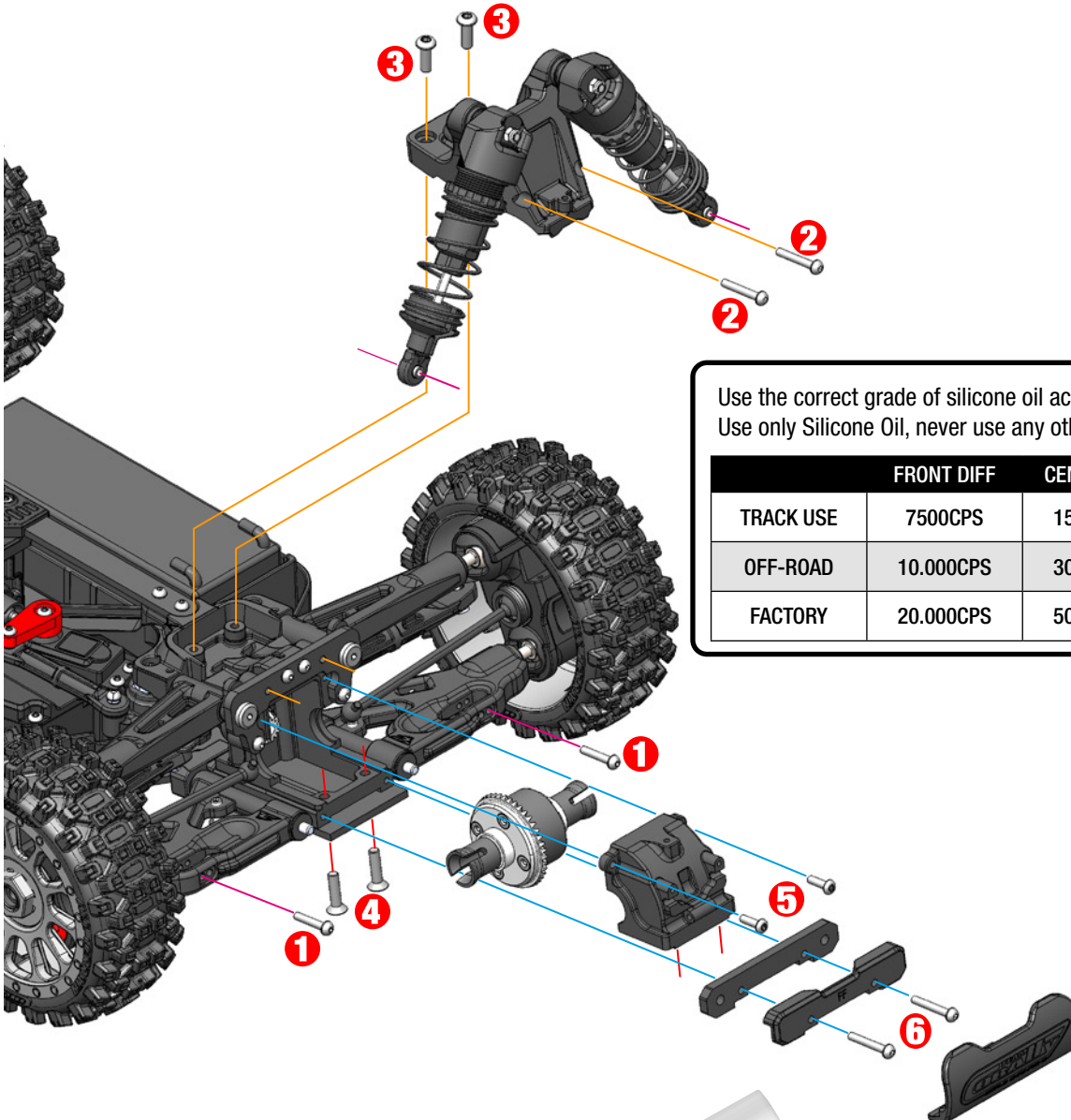

Use the correct grade of silicone oil according to the operation.
Use only Silicone Oil, never use any other types of oil.

	FRONT DIFF	CENTRE DIFF	REAR DIFF
TRACK USE	7500CPS	15.000CPS	5000CPS
OFF-ROAD	10.000CPS	30.000CPS	7500CPS
FACTORY	20.000CPS	50.000CPS	10.000CPS

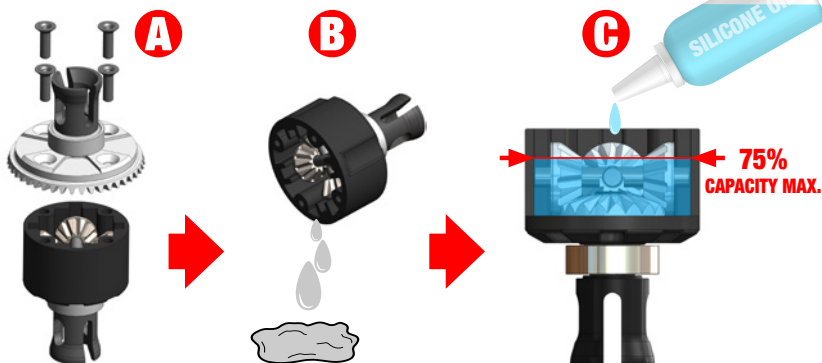

www.corally.com/Chemicals/Silicone-Oils/

REAR DIFFERENTIAL - DIFFÉRENTIEL ARRIÈRE - HINTERES DIFFERENTIAL - ACHTERSTE DIFFERENTIEEL

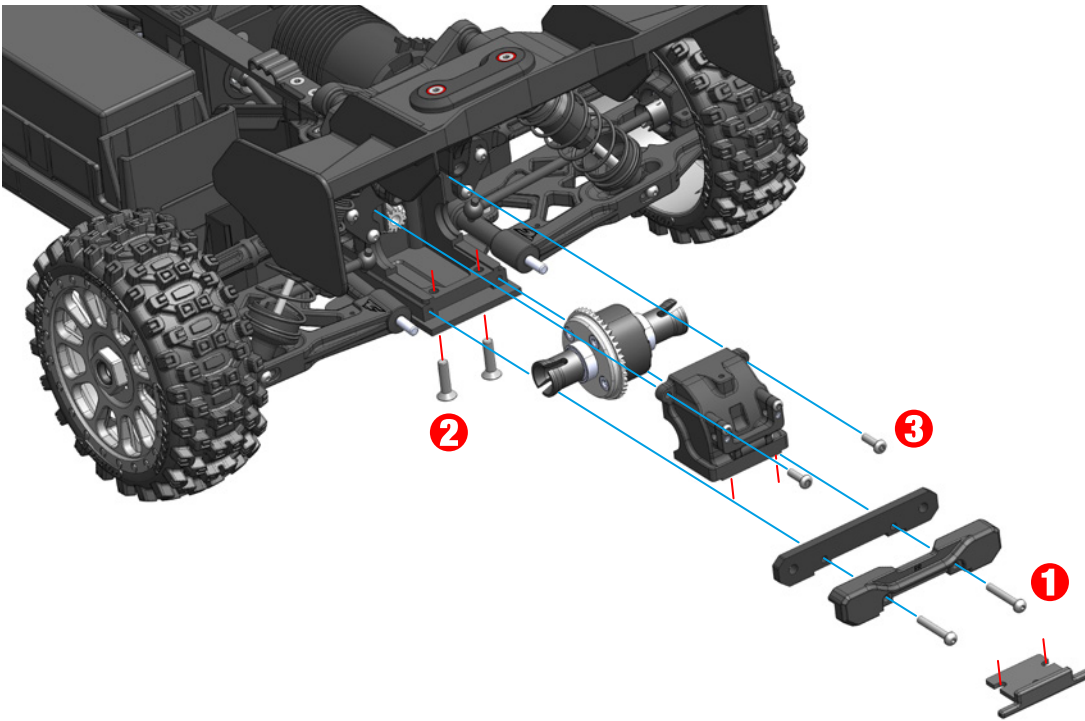

CENTRE DIFFERENTIAL - DIFFÉRENTIEL CENTRAL - MITTELDIFFERENTIAL - MIDDELSTE DIFFERENTIEELENTIEEL

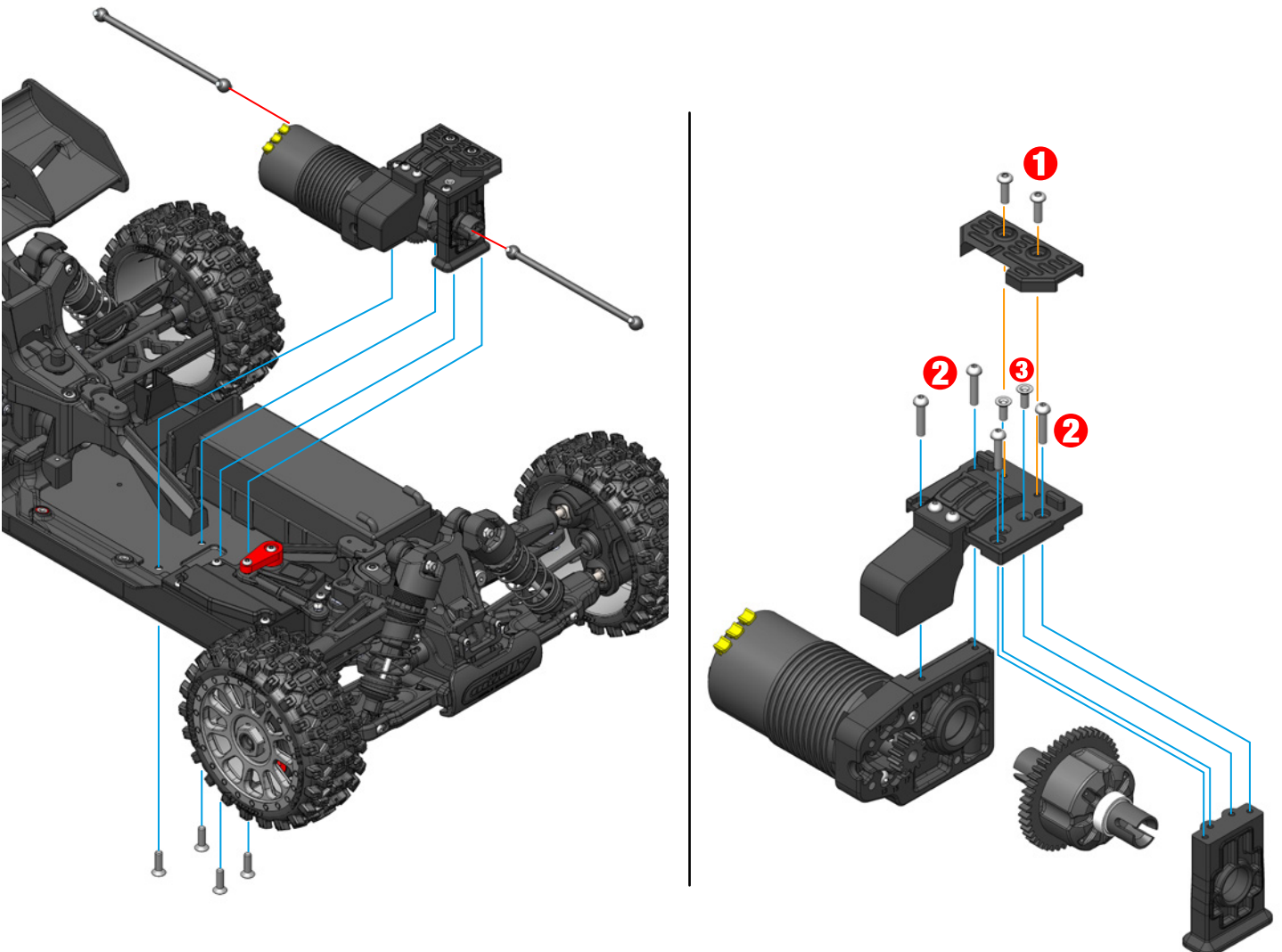

FRONT & REAR DIFFERENTIAL - DIFFÉRENTIELS AV&AR - DIFFERENTIAL VORNE UND HINTEN - VOOR & ACHTER DIFFERENTIEEL

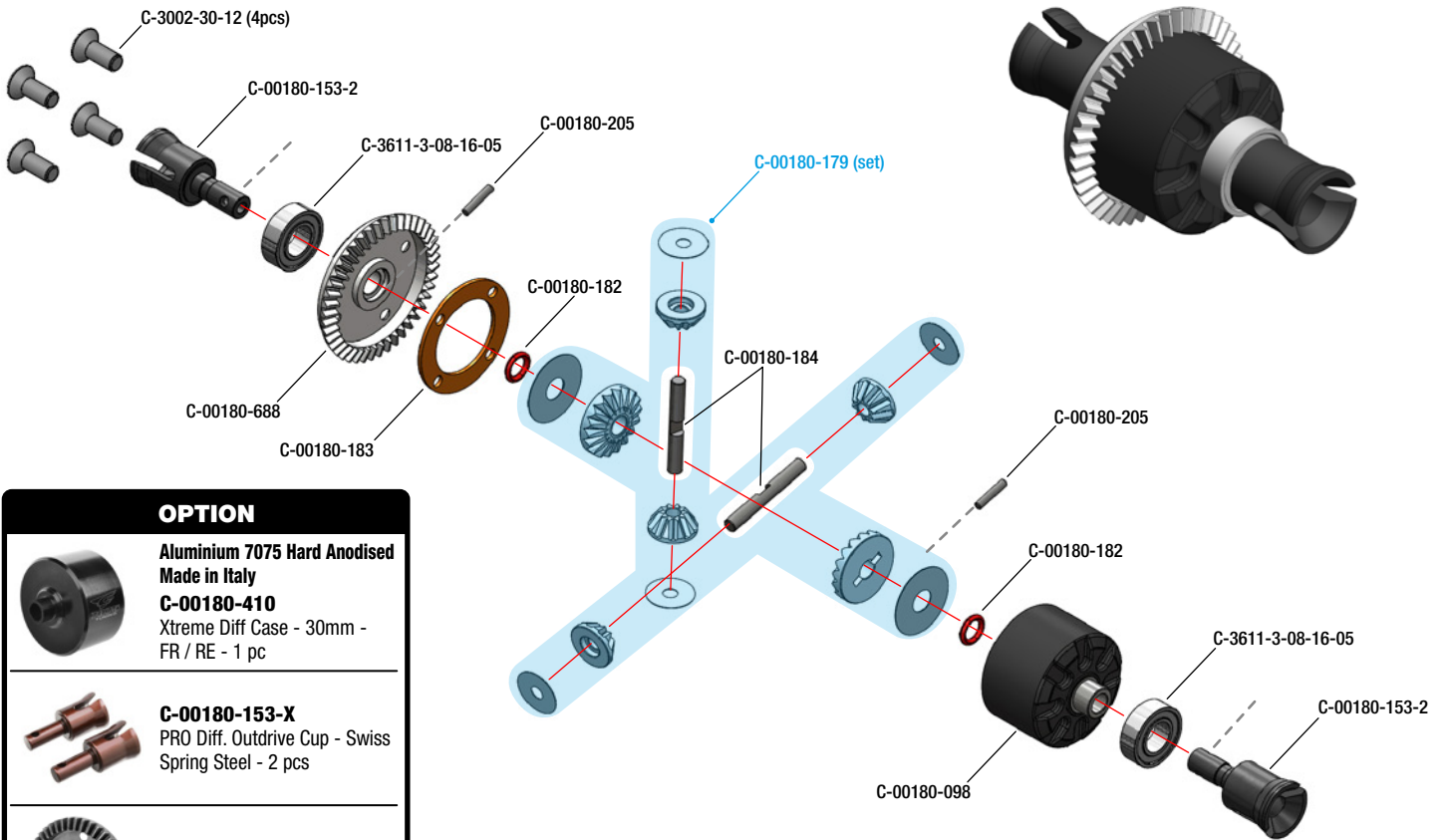

OPTION	
	Aluminium 7075 Hard Anodised Made in Italy C-00180-410 Xtreme Diff Case - 30mm - FR / RE - 1 pc
	C-00180-153-X PRO Diff. Outdrive Cup - Swiss Spring Steel - 2 pcs
	C-00180-178 Diff. Bevel Gear 43T - Steel - 1 pc

CENTRE DIFFERENTIAL - DIFFÉRENTIEL CENTRAL - ZENTRALDIFFERENTIAL - CentreDIFFERENTIEEL

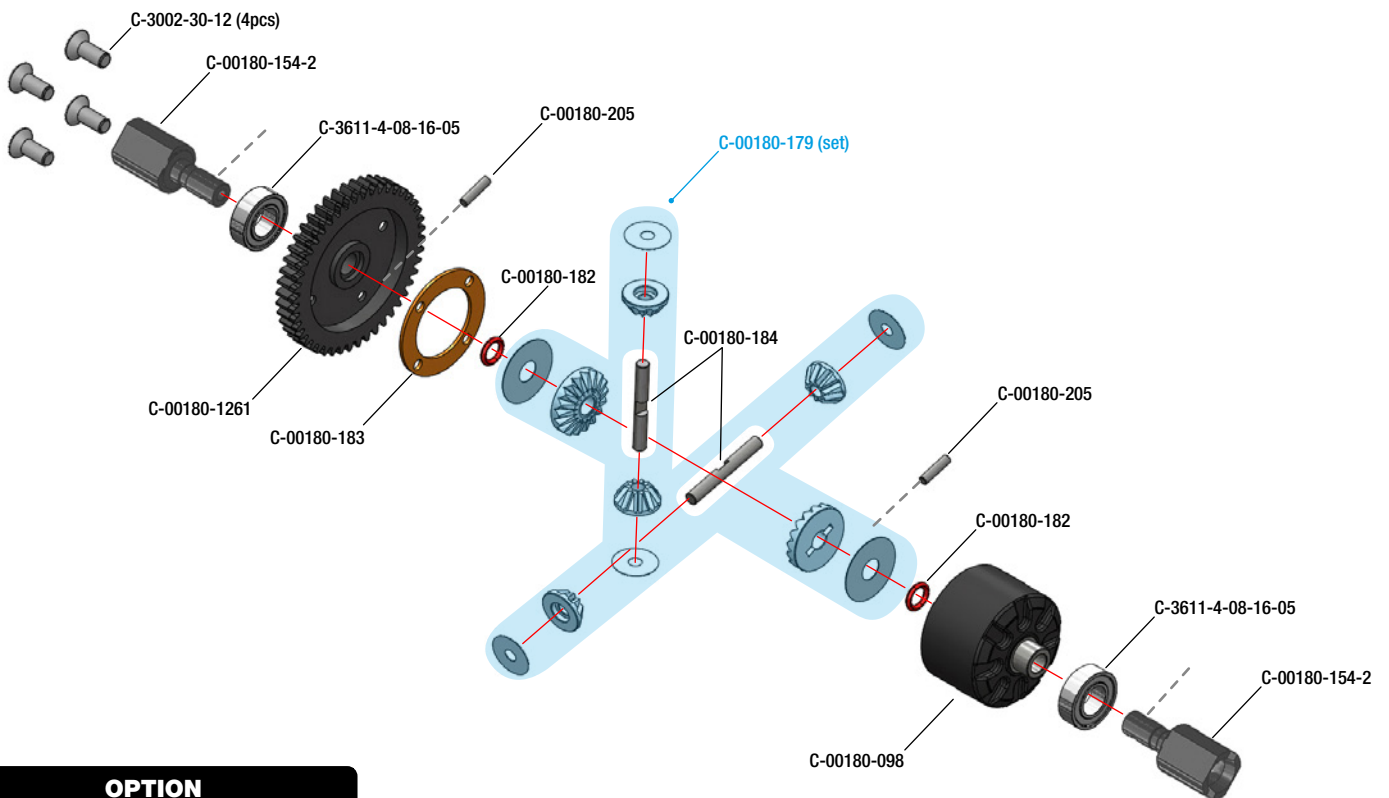

OPTION	
	C-00180-154-X PRO Centre Diff. Outdrive Cup - Swiss Spring Steel - 2 pcs

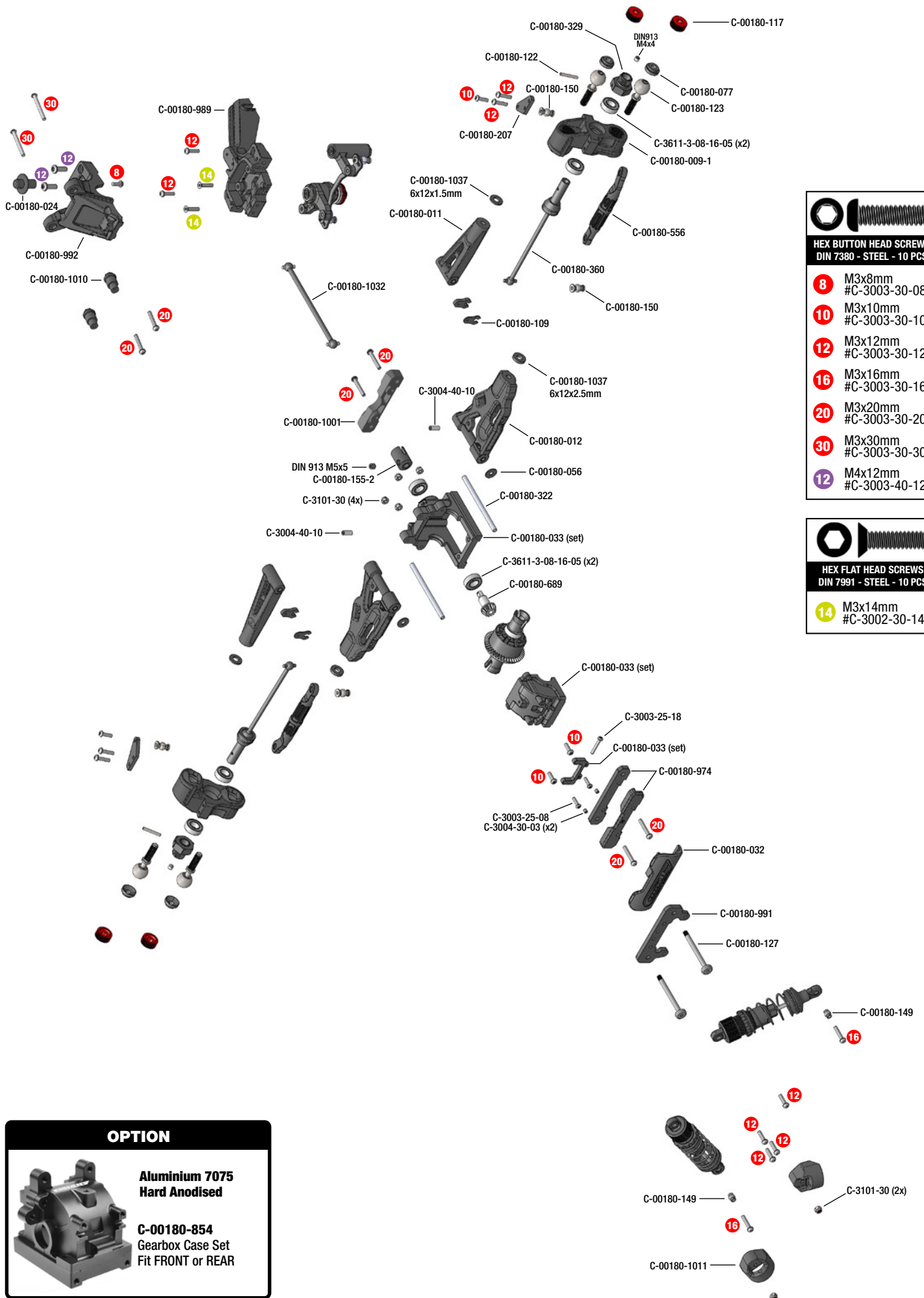

**HEX BUTTON HEAD SCREWS
DIN 7380 - STEEL - 10 PCS**

- 8** M3x8mm #C-3003-30-08
- 10** M3x10mm #C-3003-30-10
- 12** M3x12mm #C-3003-30-12
- 16** M3x16mm #C-3003-30-16
- 20** M3x20mm #C-3003-30-20
- 30** M3x30mm #C-3003-30-30
- 12** M4x12mm #C-3003-40-12



**HEX FLAT HEAD SCREWS
DIN 7991 - STEEL - 10 PCS**

- 14** M3x14mm #C-3002-30-14

OPTION

**Aluminium 7075
Hard Anodised**

C-00180-854
Gearbox Case Set
Fit FRONT or REAR

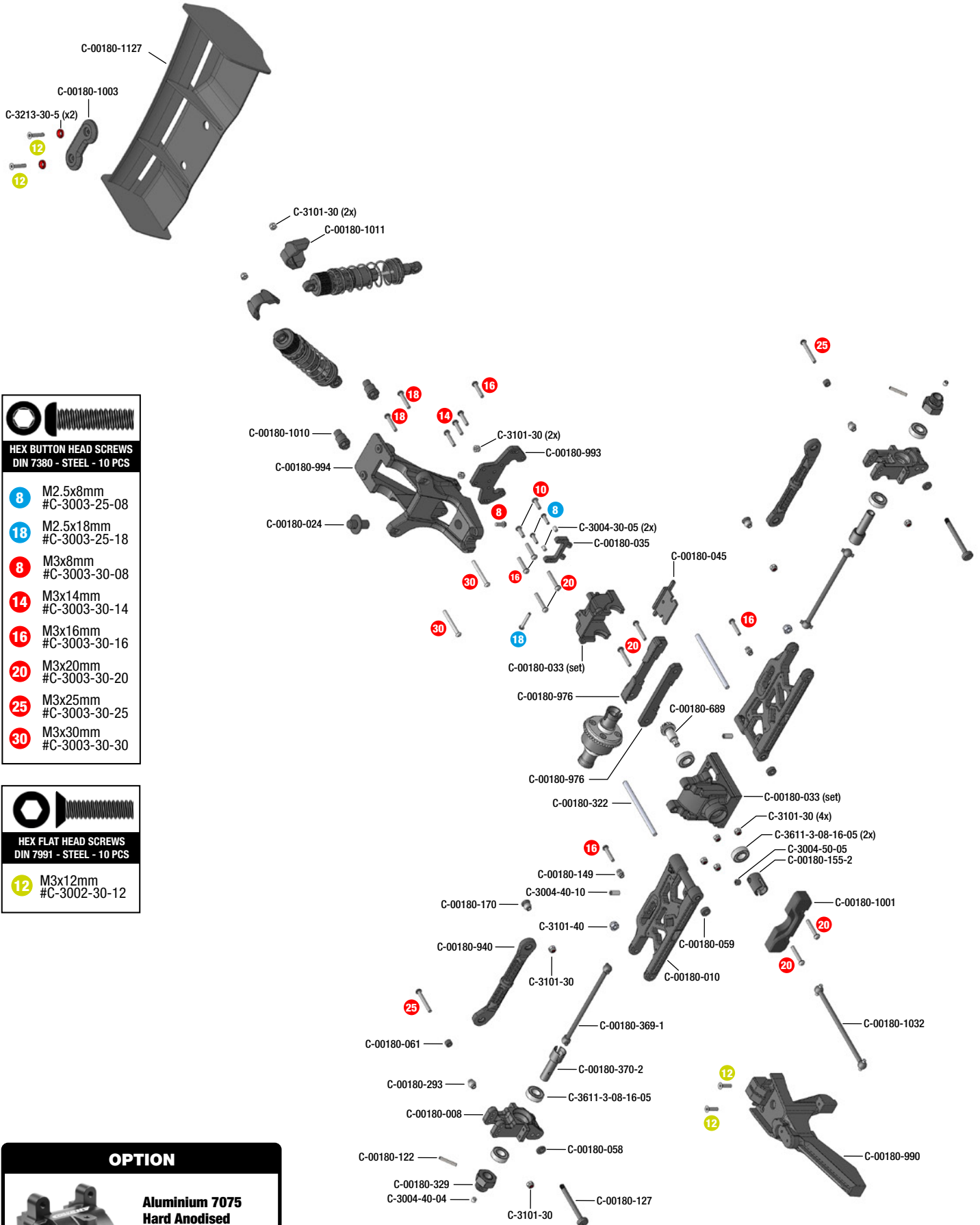

HEX BUTTON HEAD SCREWS
DIN 7380 - STEEL - 10 PCS

- 8** M2.5x8mm
#C-3003-25-08
- 18** M2.5x18mm
#C-3003-25-18
- 8** M3x8mm
#C-3003-30-08
- 14** M3x14mm
#C-3003-30-14
- 16** M3x16mm
#C-3003-30-16
- 20** M3x20mm
#C-3003-30-20
- 25** M3x25mm
#C-3003-30-25
- 30** M3x30mm
#C-3003-30-30

HEX FLAT HEAD SCREWS
DIN 7991 - STEEL - 10 PCS

- 12** M3x12mm
#C-3002-30-12

OPTION

**Aluminium 7075
Hard Anodised**

C-00180-854
Gearbox Case Set
Fit FRONT or REAR

OPTION

CENTRE DIFF ASSEMBLY - XPERT BUILD

Aluminium / Steel

C-00180-685
Centre Diff Assembly - 46T Main Gear - Xpert Build - 100K Oil Filled

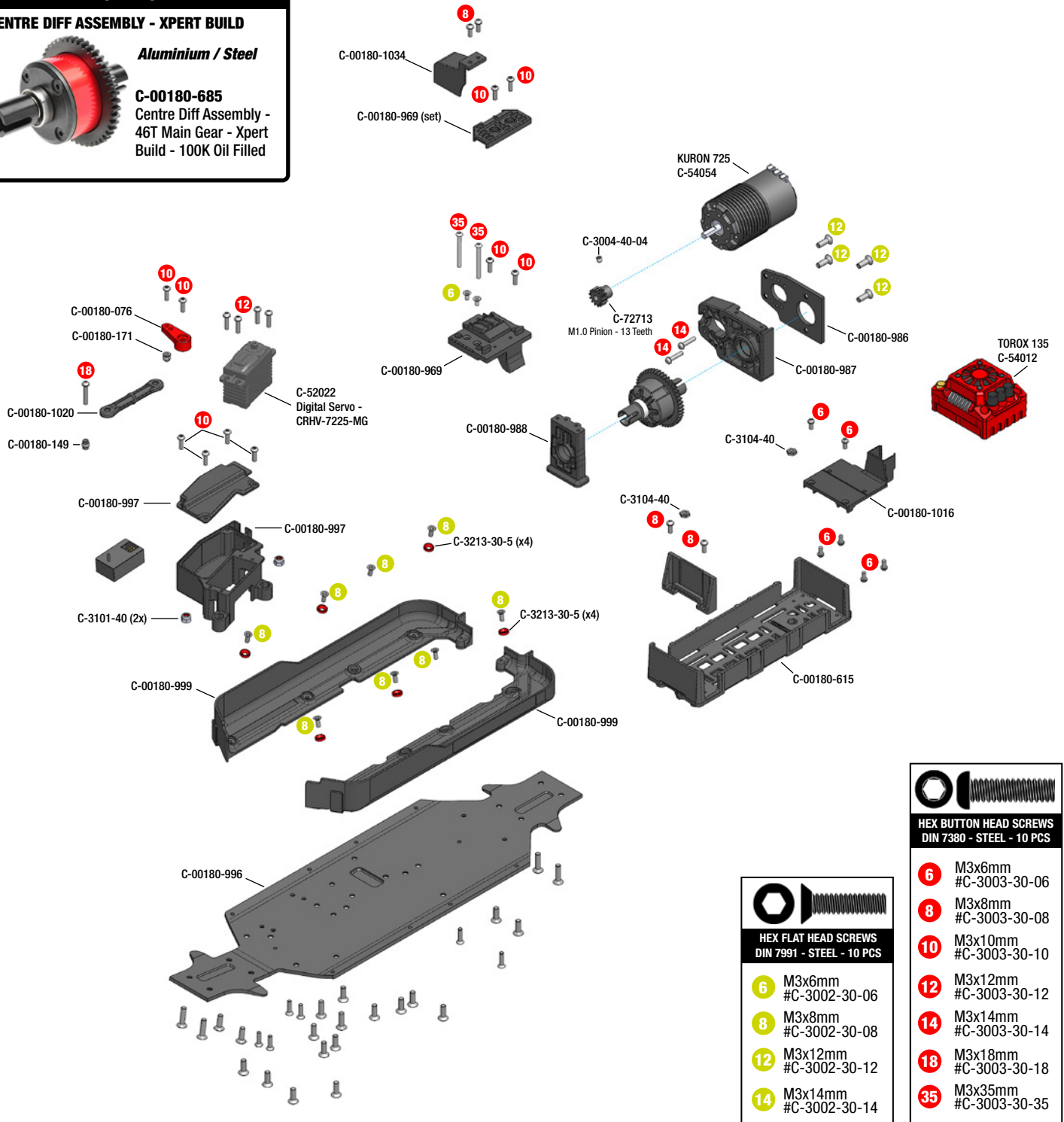



HEX BUTTON HEAD SCREWS DIN 7380 - STEEL - 10 PCS	
6	M3x6mm #C-3003-30-06
8	M3x8mm #C-3003-30-08
10	M3x10mm #C-3003-30-10
12	M3x12mm #C-3003-30-12
14	M3x14mm #C-3003-30-14
18	M3x18mm #C-3003-30-18
35	M3x35mm #C-3003-30-35

HEX FLAT HEAD SCREWS DIN 7991 - STEEL - 10 PCS	
6	M3x6mm #C-3002-30-06
8	M3x8mm #C-3002-30-08
12	M3x12mm #C-3002-30-12
14	M3x14mm #C-3002-30-14

CHASSIS - SCREWS DESCRIPTION

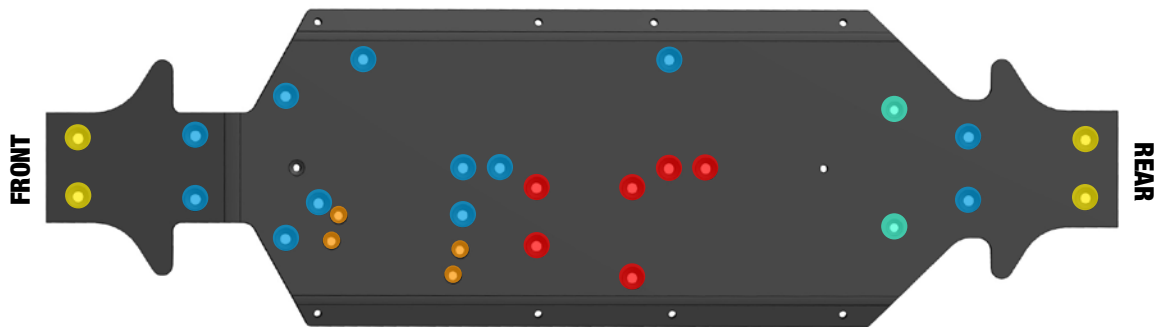
- M3x12mm DIN7991
#C-3002-30-12
- M3x18mm DIN7991
#C-3002-30-18
- M4x12mm DIN7991
#C-3002-40-12
- M4x14mm DIN7991
#C-3002-40-14
- M4x16mm DIN7991
#C-3002-40-16



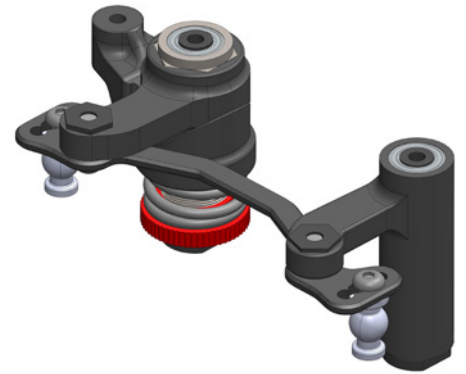
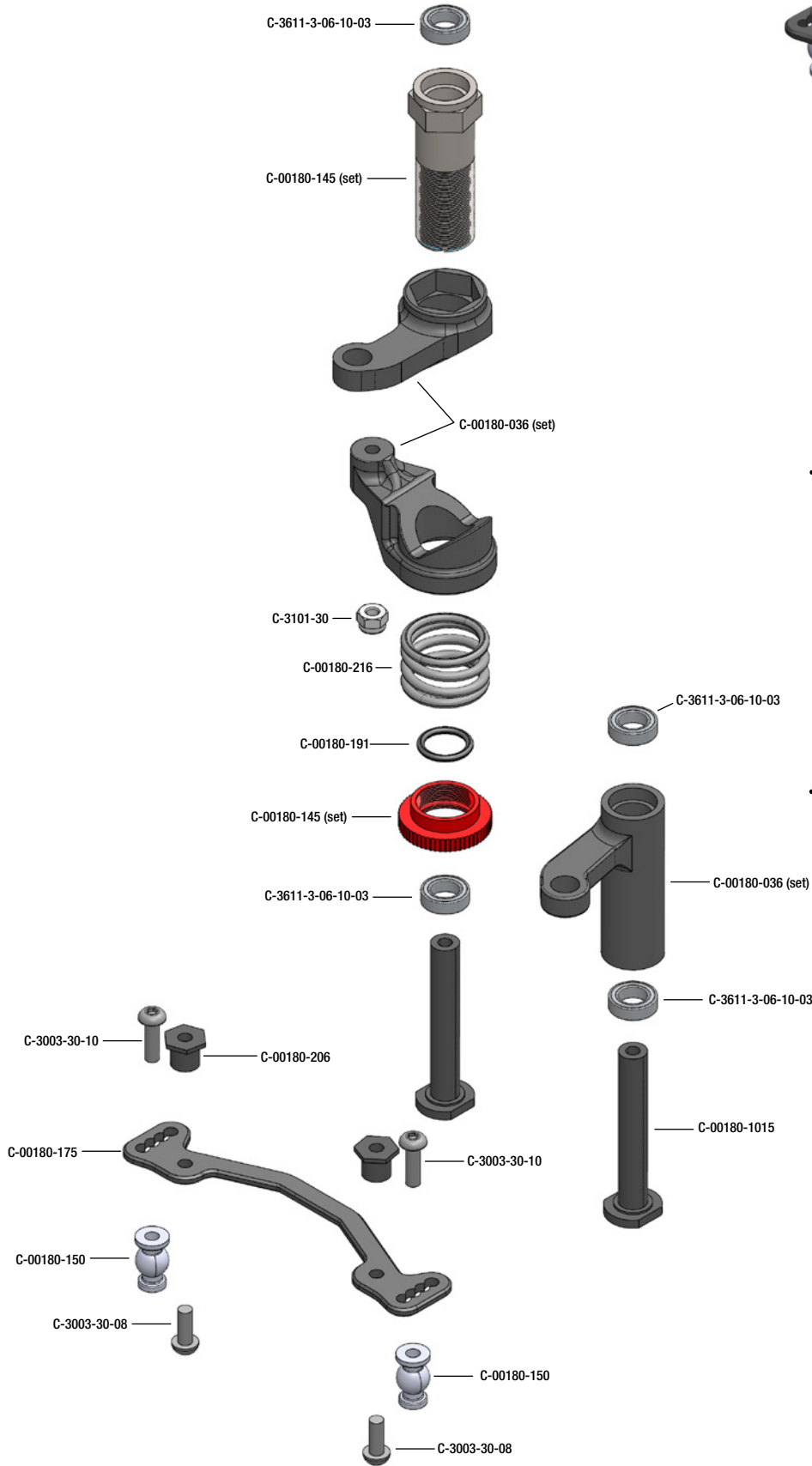

OPTION



C-00180-266
Servo Saver Steering Arm - Aluminium
7075 T6 - Hard Anodised - Black - 1 pc

OPTION



C-00180-831
Steering Rack - Dual Stiffener - Aluminium - 1 Pc



C-00180-004-1
Battery Strap - Hook & Loop
- 2 pcs



C-00180-005-2
Wing Mount - Adjustable -
Composite - 1 Set



C-00180-008
Hub - Rear - Composite - 1 pc



C-00180-009-1
HD Steering Block (1pc) - Pillow
Ball Cup (2pcs) - Composite



C-00180-010
Suspension Arm - Lower - Rear
- Composite - 1 pc



C-00180-011
Suspension Arm - Upper - Front
- Composite - 1 pc



C-00180-012
Suspension Arm - Lower - Front
- Composite - 1 pc



C-00180-024
Body Post - Composite - 2 pcs

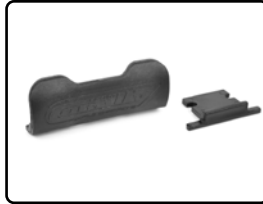

C-00180-032
Bumper - Front - Rear - Com-
posite - 1 set



C-00180-033
Gearbox Case Set - Composite
- 1 Set



C-00180-036
Steering Bellcrank - Parts A-B-C
- Composite - 1 Set

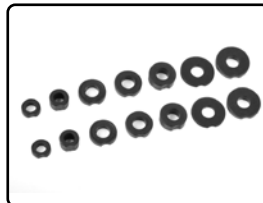

C-00180-055
Suspension Arm Shim - Com-
posite - 1 Set



C-00180-109
Caster Clips Set - 1 to 4.5mm
- 1 Set



C-00180-117
Pivot Ball Adjusting Nut - Alu-
minium - 4 pcs

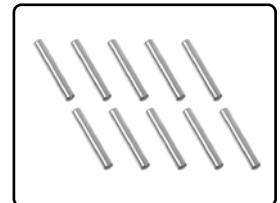

C-00180-122
Pin 2.5x17mm - Steel - 10 pcs



C-00180-123
Pivot Ball - Steel - 4 pcs



C-00180-127
Hinge Pin - Outer - Steel - 2 pcs



C-00180-145
Servo Saver Shaft w/ Nut -
Aluminium - 1 pc



C-00180-149
Ball - 5.8mm - Steel - 4 pcs



C-00180-150
Ball Shouldered - 6.8mm - Steel
- 4 pcs



C-00180-171
Threaded Ball - 6mm - Steel -
2 pcs



C-00180-175
Steering Rack - Aluminium - 1 pc



C-00180-206
Steering Rack Bushing - Steel
- 2 pcs



C-00180-207
Steering Block Arms - Alumi-
nium - 2 pcs



C-00180-216
Servo Saver Spring - 1 pc

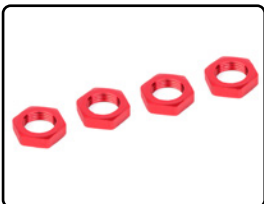

C-00180-230
Wheel Nut - Aluminium -
Ribbed - 4 pcs



C-00180-293
Ball 6.8mm - Steel - 4 pcs

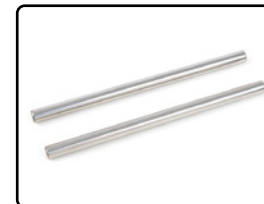

C-00180-322
Suspension Arm Pivot Pin - Low-
er Inner - Fr/Re - Steel - 2 pcs



C-00180-329
Wheel Hex Adapter - Wide RTR
- Aluminium - 2 pcs



C-00180-360
Universal Joint Drive Shaft -
Buggy - Front - 1 pc



C-00180-369-1
Dogbones - Short - Rear - Steel
- 2 pcs



C-00180-370-2
Wheel Drive Axle - Buggy - Rear
- 2 pcs



C-00180-372
Servo Arm - Steering - Alu -
1 pc



C-00180-615
Battery Tray - Large - Compos-
ite - 1 Pc



C-00180-770
HD Shock End - Short - Com-
posite - 4 pcs



C-00180-555-1
Steering Links - Buggy - 77mm
- Composite



C-00180-556-1
Camber Links Rear - Buggy -
Composite - 2 pcs



C-00180-969
Centre Diff Plate - Pinion Gear
Cover - XB - Composite - 1 pc

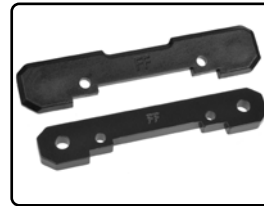

C-00180-974
Suspension Arm Mount - FR - Alu.
4mm - Composite Cover - 1 Set



C-00180-976
Suspension Arm Mount - RR - Alu.
4mm - Composite Cover - 1 Set

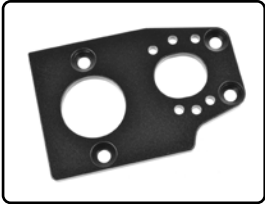

C-00180-986
Motor Mount Plate - Aluminium
- 1 pc



C-00180-987
Motor Mount / Diff Bulkhead -
Composite - 1 pc



C-00180-989
Chassis Brace - EB - Front -
Composite - 1 pc



C-00180-990
Chassis Brace - EB - Rear -
Composite - 1 pc

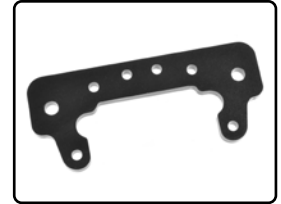

C-00180-991
Hinge Pin Plate - EB - Front -
Aluminium 4mm - 1 pc



C-00180-992
Shock Tower - EB - Front -
Composite - 1 pc



C-00180-993
Shock Tower - Wing Mount -
EB - Rear - Composite - 1 pc



C-00180-994
Shock Tower - Wing Mount -
EB - Rear - Composite - 1 pc

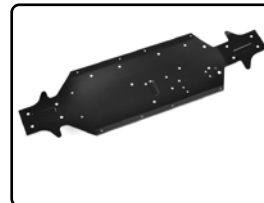

C-00180-996
Chassis - EB - Aluminium 3mm
- Black - 1 pc



C-00180-997
Servo Mount - Receiver Box -
M23 - Composite - 1 Set



C-00180-999
Side Guards - EB - Left-Right -
Composite - 1 Set



C-00180-1001
Suspension Arm Mount - RF -
FR - Composite - 1 Set



C-00180-1003
Wing Washer - EB - Composite
- 1 Pc



C-00180-1004
Esc switch mount plate - Com-
posite - 1 pc



C-00180-1006
Off-Road 1/8 Buggy Tires -
Scorpion XTB - Rims - 1 pair



C-00180-1010
Shock Spacer - 4 pcs



C-00180-1015
Servo Saver Post - EB - Steel
- 2 pcs

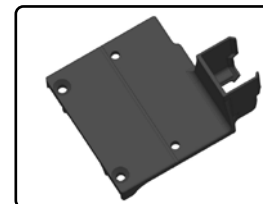

C-00180-1016
ESC Plate - Composite - 1 pc



C-00180-1020
Servo Steering Link - Compos-
ite - 1 pc



C-00180-1032
Drive Shaft - Centre - 97mm -
Steel - 1 pc



C-00180-1034
Pinion Cover for Centre Diff
Plate - Composite - 1 pc

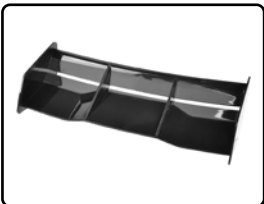

C-00180-1127
Wing - Composite - 1 pc



C-72713
M1.0 Pinion - Hardened Steel -
Shaft Diameter 5mm



C-00180-1055-G
SYNCR0 4 - Body - Painted -
Green - Buggy - 1 pc



C-00180-1055-O
SYNCR0 4 - Body - Painted -
Orange - Buggy - 1 pc



C-00180-1055-R
SYNCR0 4 - Body - Painted -
Red - Buggy - 1 pc



C-00180-1055-B
SYNCR0 4 - Body - Painted -
Blue - Buggy - 1 pc



C-54012
Speed Controller - TOROX 135 -
Brushless - 2-4S



C-52022
Digital Servo - High Voltage -
Metal Gear - 25 Kg Torque



C-54054
Kuron 725 - Brushless Motor -
Sensorless

FR & RE DIFFERENTIAL - SPARE PARTS



C-00180-689
Bevel Pinion 13T - Steel - 1 pc



C-00180-688
Diff. Bevel Gear 43T - Molded Steel - 1 pc

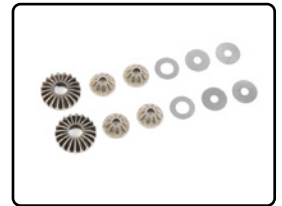

C-00180-179
Planetary Diff. Gears - Steel - 1 Set



C-00180-184
Gear Diff. Pin - Steel - 2 pcs



C-00180-205
Diff. Outdrive Pin - 2x11,8mm - Steel - 4 pcs



C-00180-098
Diff Case - FR-RE - Composite - 1 pc

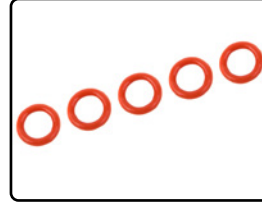

C-00180-182
O-Ring - Silicone - 5x8mm - 5 pcs

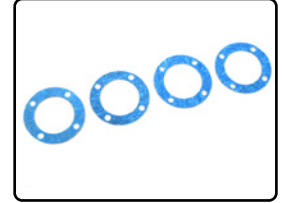

C-00180-183
Diff. Gasket - 4 pcs



C-00180-153-2
Diff. Outdrive Cup - Steel - 2 pcs



C-00180-155-2
Pinion Outdrive Cup - Steel - 2 pcs

CENTRE DIFFERENTIAL - SPARE PARTS

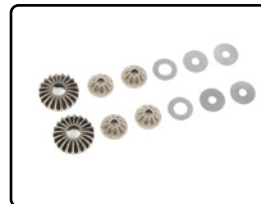

C-00180-179
Planetary Diff. Gears - Steel - 1 Set



C-00180-184
Gear Diff. Pin - Steel - 2 pcs

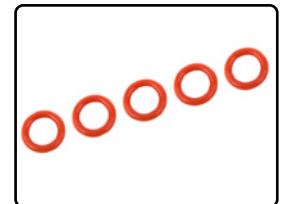

C-00180-182
O-Ring - Silicone - 5x8mm - 5 pcs

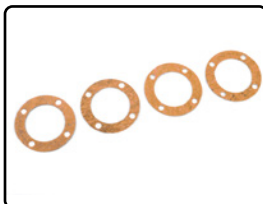

C-00180-183-1
Centre Diff. Gasket - 4 pcs



C-00180-205
Diff. Outdrive Pin - 2x11,8mm - Steel - 4 pcs



C-00180-154-2
Centre Diff. Outdrive Cup - Steel - 2 pcs



C-00180-098
Diff Case - Centre - Composite - 1 pc

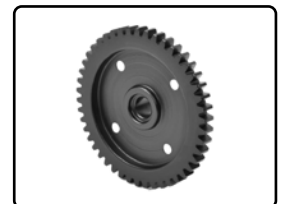

C-00180-1261
Spur Gear 46T - Molded Steel - 1 pc

SHOCK ABSORBER - SPARE PARTS



C-00180-1011
Shock Cap Protector - EB - Composite - 2 pcs



C-00180-1025
Maintenance Kit 1 - Composite Shocks - 1 Set

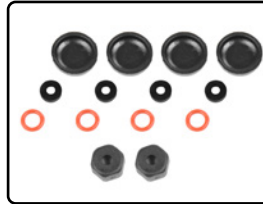

C-00180-1026
Maintenance Kit 2 - Composite Shocks - 1 Set

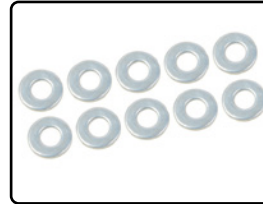

C-00180-190
Shock Washer - 2.5x6x0.5mm - Steel - 10 pcs

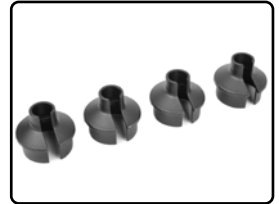

C-00180-029
Shock Spring Cup - Composite - 4 pcs



C-00180-164
Shock Shaft - 66mm - Rear - Steel - 2 pcs



C-00180-165
Shock Shaft - 55mm - Front - Steel - 2 pcs



C-00180-770
HD Shock End - Short - Composite - 4 pcs

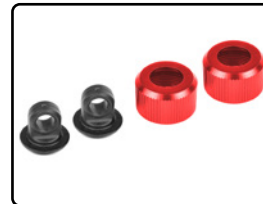

C-00180-1008
Shock Cap - Ring Set - 2 pcs

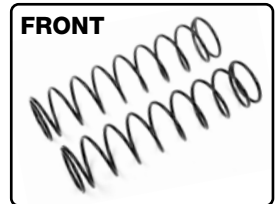

C-00180-627
Shock Spring - Medium - Front - 2 pcs

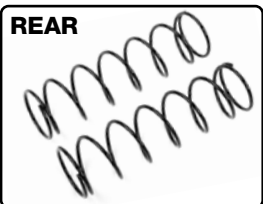

C-00180-290
Shock Spring - Medium - 1.6mm - 84-86mm - 2 pcs



C-00180-1023
Shock Absorber body - Front - Composite - 2 pcs



C-00180-1030
Shock Absorber body - Rear - Composite - 2 pcs





C-00180-153-X
PRO Diff. Outdrive Cup - Swiss
Spring Steel - 2 pcs



C-00180-155-X
PRO Pinion Outdrive Cup -
Swiss Spring Steel - 2 pcs



C-00180-154-X
PRO Centre Diff. Outdrive Cup -
Swiss Spring Steel - 2 pcs



C-00180-365
Universal Joint Drive Shaft -
Buggy - Rear - 1 pc



C-00180-1019
Chassis Brace - EB - Alumi-
um - 1 pc

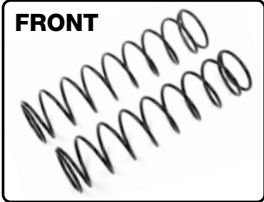

C-00180-626
Shock Spring - Soft - 1.4mm -
75-77mm - 2 pcs

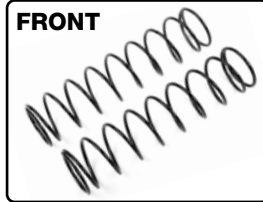

C-00180-628
Shock Spring - Hard - 1.8mm -
75-77mm - 2 pcs

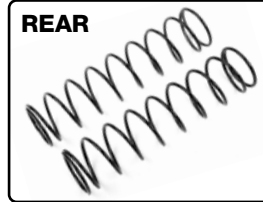

C-00180-289
Shock Spring - Soft - 1.4mm -
84-86mm - 2 pcs

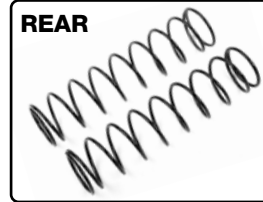

C-00180-291
Shock Spring - Hard - 1.8mm -
84-86mm - 2 pcs



C-00180-831
Steering Rack - Dual Stiffener -
Aluminium - 1 PC



C-00180-410
Xtreme Diff Case - 30mm -
FR / RE - Made in Italy - 1 pc



C-00180-685
Centre Diff Assembly - Alum. /
Steel - 46T Main Gear



C-00180-611
Off-Road 1/8 Buggy Tires - Xprtt
- Low Profile - Rims - 1 pair



C-00180-178
Diff. Bevel Gear 43T - CNC Cut -
Steel - 1 Pc



C-00180-156
Bevel Pinion 13T - CNC Cut
Steel - 1 PC



C-00180-266
Servo Saver Steering Arm - Alu.
7075 T6 - Hard Anodised - 1 pc

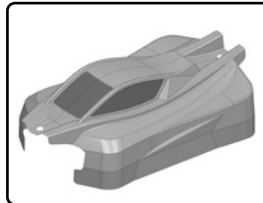

C-00180-1055
SYNCRO 4 - Body - Clear -
Buggy - 1 pc



C-00180-1055-1R • Red - 1 pc
C-00180-1055-1B • Blue - 1 pc
C-00180-1055-1G • Green - 1 pc
C-00180-1055-1O • Orange - 1 pc



M1.0 Pinion - Hardened Steel -
Shaft Diameter 5mm
C-72715 • 15 Teeth
C-72717 • 17 Teeth

**For more tuning parts, visit the
“Car Spares - Tuning / 1/8 Sport - RTR Series”
section on www.corally.com.**



<https://corally.com/en/catalog/car-spares-tuning/18-sport-rtr-series>

STEEL SCREWS

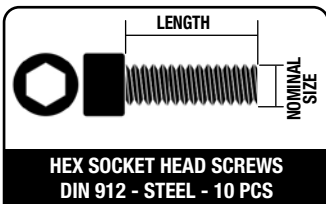

REF	NOMINAL SIZE	LENGTH MM
C-3001-16-06	M1.6	6
C-3001-20-04	M2	4
C-3001-20-08	M2	8
C-3001-20-10	M2	10
C-3001-20-12	M2	12
C-3001-20-16	M2	16
C-3001-25-06	M2.5	6
C-3001-25-08	M2.5	8
C-3001-25-10	M2.5	10
C-3001-25-12	M2.5	12
C-3001-25-16	M2.5	16
C-3001-25-20	M2.5	20
C-3001-30-06	M3	6
C-3001-30-08	M3	8
C-3001-30-10	M3	10
C-3001-30-12	M3	12
C-3001-30-14	M3	14
C-3001-30-16	M3	16
C-3001-30-18	M3	18
C-3001-30-20	M3	20
C-3001-30-25	M3	25
C-3001-30-30	M3	30
C-3001-40-06	M4	6
C-3001-40-08	M4	8
C-3001-40-10	M4	10
C-3001-40-12	M4	12
C-3001-40-14	M4	14
C-3001-40-16	M4	16
C-3001-40-18	M4	18
C-3001-40-20	M4	20
C-3001-40-22	M4	22

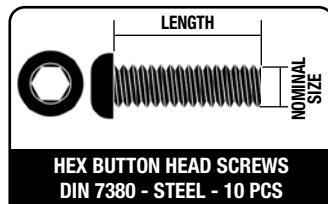

REF	NOMINAL SIZE	LENGTH MM
C-3003-25-04	M2.5	4
C-3003-25-06	M2.5	6
C-3003-25-08	M2.5	8
C-3003-25-18	M2.5	18
C-3003-30-06	M3	6
C-3003-30-08	M3	8
C-3003-30-10	M3	10
C-3003-30-12	M3	12
C-3003-30-14	M3	14
C-3003-30-16	M3	16
C-3003-30-18	M3	18
C-3003-30-20	M3	20
C-3003-30-23	M3	23
C-3003-30-25	M3	25
C-3003-30-28	M3	28
C-3003-30-35	M3	35
C-3003-30-40	M3	40
C-3003-40-08	M4	8
C-3003-40-10	M4	10
C-3003-40-12	M4	12
C-3003-40-14	M4	14
C-3003-40-16	M4	16
C-3003-40-18	M4	18
C-3003-40-20	M4	20
C-3003-40-25	M4	25

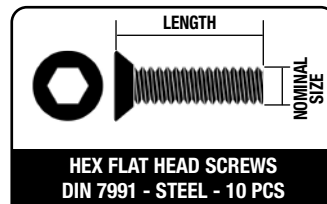

REF	NOMINAL SIZE	LENGTH MM
C-3002-25-08	M2.5	8
C-3002-30-06	M3	6
C-3002-30-08	M3	8
C-3002-30-10	M3	10
C-3002-30-12	M3	12
C-3002-30-14	M3	14
C-3002-30-15	M3	15
C-3002-30-16	M3	16
C-3002-30-18	M3	18
C-3002-30-20	M3	20
C-3002-40-06	M4	6
C-3002-40-08	M4	8
C-3002-40-10	M4	10
C-3002-40-12	M4	12
C-3002-40-14	M4	14
C-3002-40-16	M4	16
C-3002-40-18	M4	18
C-3002-40-20	M4	20
C-3002-40-25	M4	25

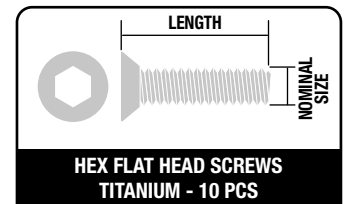

REF	NOMINAL SIZE	LENGTH MM
C-3022-30-06	M3	6
C-3022-30-08	M3	8
C-3022-30-10	M3	10
C-3022-30-12	M3	12
C-3022-30-14	M3	14
C-3022-30-16	M3	16
C-3022-30-18	M3	18
C-3022-30-20	M3	20
C-3022-40-08	M4	8
C-3022-40-10	M4	10
C-3022-40-12	M4	12
C-3022-40-16	M4	16
C-3002-40-20	M4	20

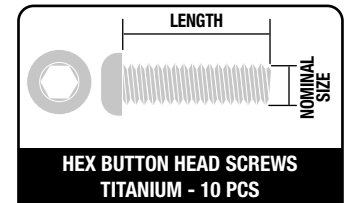

REF	NOMINAL SIZE	LENGTH MM
C-3023-30-06	M3	6
C-3023-30-08	M3	8
C-3023-30-10	M3	10
C-3023-30-12	M3	12
C-3023-30-16	M3	16
C-3023-30-20	M3	20
C-3023-30-25	M3	25
C-3023-40-06	M4	6
C-3023-40-08	M4	8
C-3023-40-10	M4	10
C-3023-40-12	M4	12
C-3023-40-16	M4	16
C-3023-40-20	M4	20
C-3023-40-25	M4	25

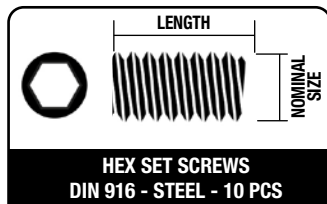

REF	NOMINAL SIZE	LENGTH MM
C-3004-25-03	M2.5	3
C-3004-30-03	M3	3
C-3004-30-05	M3	5
C-3004-30-08	M3	8
C-3004-30-10	M3	10
C-3004-30-12	M3	12
C-3004-30-20	M3	20
C-3004-40-04	M4	4
C-3004-40-06	M4	6
C-3004-40-08	M4	8
C-3004-40-10	M4	10
C-3004-40-12	M4	12
C-3004-50-05	M5	5



Download the full list of screws and bolts here!

Téléchargez la liste complète de visserie ici !

Laden Sie hier die komplette Liste der Schrauben herunter!

Download hier de volledige lijst met schroeven en bouten!



NUTS

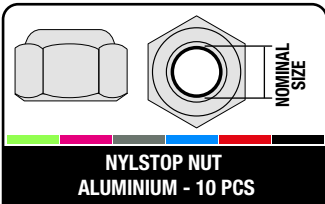

**NYLSTOP NUT
ALUMINIUM - 10 PCS**

REF	NOMINAL SIZE	COLOR
C-3106-20-0	M2	Gold
C-3106-20-1	M2	Green
C-3106-20-2	M2	Purple
C-3106-20-3	M2	Gun
C-3106-20-4	M2	Blue
C-3106-20-5	M2	Red
C-3106-20-6	M2	Black
C-3106-30-0	M3	Gold
C-3106-30-1	M3	Green
C-3106-30-2	M3	Purple
C-3106-30-3	M3	Gun
C-3106-30-4	M3	Blue
C-3106-30-5	M3	Red
C-3106-30-6	M3	Black
C-3106-40-0	M4	Gold
C-3106-40-1	M4	Green
C-3106-40-2	M4	Purple
C-3106-40-3	M4	Gun
C-3106-40-4	M4	Blue
C-3106-40-5	M4	Red
C-3106-40-6	M4	Black
C-3106-50-0	M5	Gold
C-3106-50-1	M5	Green
C-3106-50-2	M5	Purple
C-3106-50-3	M5	Gun
C-3106-50-4	M5	Blue
C-3106-50-5	M5	Red
C-3106-50-6	M5	Black

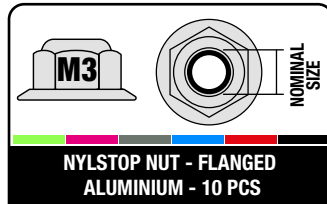

**NYLSTOP NUT - FLANGED
ALUMINIUM - 10 PCS**

REF	NOMINAL SIZE	COLOR
C-3107-30-0	M3	Gold
C-3107-30-1	M3	Green
C-3107-30-2	M3	Purple
C-3107-30-3	M3	Gun
C-3107-30-4	M3	Blue
C-3107-30-5	M3	Red
C-3107-30-6	M3	Black
C-3107-40-0	M4	Gold
C-3107-40-1	M4	Green
C-3107-40-2	M4	Purple
C-3107-40-3	M4	Gun
C-3107-40-4	M4	Blue
C-3107-40-5	M4	Red
C-3107-40-6	M4	Black
C-3107-50-0	M5	Gold
C-3107-50-1	M5	Green
C-3107-50-2	M5	Purple
C-3107-50-3	M5	Gun
C-3107-50-4	M5	Blue
C-3107-50-5	M5	Red
C-3107-50-6	M5	Black

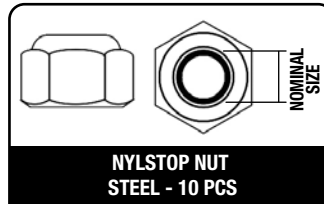

**NYLSTOP NUT
STEEL - 10 PCS**

REF	NOMINAL SIZE	COLOR
C-3101-20-6	M2	Black
C-3101-25-6	M2.5	Black
C-3101-30-6	M3	Black
C-3101-40-6	M4	Black

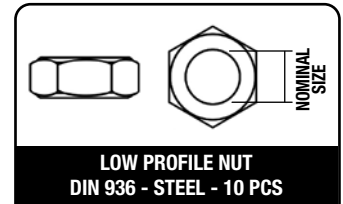

**LOW PROFILE NUT
DIN 936 - STEEL - 10 PCS**

REF	NOMINAL SIZE	COLOR
C-3104-40	M4	Silver
C-3104-50	M5	Silver

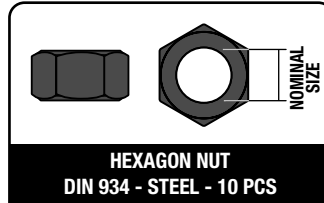

**HEXAGON NUT
DIN 934 - STEEL - 10 PCS**

REF	NOMINAL SIZE	COLOR
C-3103-20-6	M2	Black
C-3103-25-6	M2.5	Black
C-3103-30-6	M3	Black
C-3103-40-6	M4	Black

BALL BEARINGS

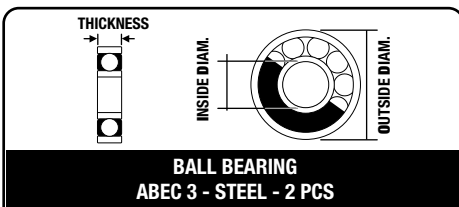

**BALL BEARING
ABEC 3 - STEEL - 2 PCS**

REF	ID MM	OD MM	TH MM
C-3611-3-03-06-25	3	6	2.5
C-3611-3-05-08-25	5	8	2.5
C-3611-3-05-10-04	5	10	4
C-3611-3-06-10-03	6	10	3
C-3611-3-08-16-05	8	16	5
C-3611-3-10-15-04	10	15	4
C-3611-3-12-21-05	12	21	5

SHIMS

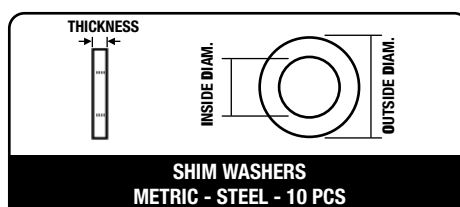

**SHIM WASHERS
METRIC - STEEL - 10 PCS**

REF	ID MM	OD MM	TH MM
C-3301-04-06-01	4	6	0.1
C-3301-05-07-01	5	7	0.1
C-3301-06-12-03	6	12	0.3
C-3301-06-12-05	6	12	0.5
C-3301-06-12-10	6	12	1.0
C-3301-06-08-01	6	8	0.1
C-3301-08-10-01	8	10	0.1
C-3301-13-16-01	13	16	0.1

STEELWASHERS

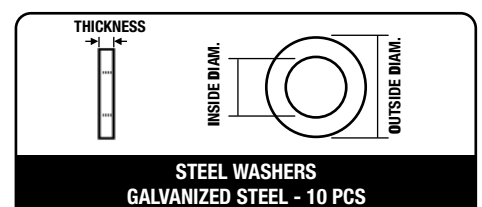

**STEEL WASHERS
GALVANIZED STEEL - 10 PCS**

REF	ID MM	OD MM	TH MM
C-3201-40	4.3	9	0.8
C-3201-60	6.4	12	1.6

DECLARATION OF CONFORMITY
EU-Konformitätserklärung/ Déclaration de Conformité UE

(in accordance with ISO/IEC 17050-1) / (in Übereinstimmung mit ISO/IEC 17050-1) /
 (Conformément à la norme ISO/IEC 17050-1)

Description : **SYNCRO 4 - BUGGY 4WD - 1/8 -RTR**
 Item Number: **C-00287**

This declaration is issued under the sole responsibility of the manufacturer.
 Die alleinige Verantwortung für die Ausstellung dieser Erklärung trägt der Hersteller.
 La présente déclaration est établie sous la seule responsabilité du fabricant.

Product(s)/Produkt(e)/ Produit(s) : **SYNCRO 4 - BUGGY 4WD - 1/8 -RTR**

The object of declaration described above is in conformity with the relevant Union harmonization Legislation, specifically the requirements of the specifications listed below, following the provisions of the European RED Directive 2014/53/EU:
 Der Gegenstand dieser Erklärung ist konform mit den Harmonisierungsrechtsvorschriften der Europäischen Union, insbesondere mit den unten aufgeführten Bestimmungen, und folgt der europäischen RED Direktive 2014/53/EU:
 L'objet de la déclaration décrit ci-dessus est conforme à la législation pertinente en matière d'harmonisation de l'Union européenne, en particulier les exigences des spécifications énumérées ci-dessous, conformément aux dispositions des directives européennes RED 2014/53/EU:

- | | |
|---------------------------|---|
| EN 301 489-1 V2.2.3:2019 | EN 301 489-3 V1.6.1:2013 |
| EN 301 489-17 V3.2.4:2020 | EN 60950-1:2006+A11:2009+A1:2010+A12:2011+A2:2013 |
| EN 62479:2010 | EN 55024:2010+A1:2015 |
| EN 55032:2015 | EN 61000-3-3:2013 |
| EN 61000-3-2:2014 | EN 300 328 V2.2.2:2019 |
| EN 62368-1:2020+A11:2020 | EN 50581:2012 |

JSP GROUP INTL • Geelseweg, 80 • 2250 Olen • Belgium

Signed for and on behalf of/ Unterzeichnet für und im Namen von/ Signé pour et au nom de :

Place/Ort/Lieu and Date/Datum/Data : **Olen, Belgium, 10 January 2024**

Name/Nom: **Stefan Engelen**
 Title/Titel/Titre : **Ceo**

Signature/Unterschrift : 



EQUIPMENT AUTHORIZATION is hereby issued to the named GRANTEE JSP GROUP INTL BVBA / CORALLY, and is VALID ONLY for the equipment identified hereon for use under the Commission's Rules and Regulations listed below.

FCC IDENTIFIER : **2ASZJ-C59065**
 Name of Grantee : **JSP GROUP INTL BVBA / CORALLY**
 Equipment Class : **Part 15 Low Power Communication Device Transmitter**
 Notes : **Corally CT-2-S**
 FCC Rules : **15C**
 Frequency Range (MHZ) : **2410.0 - 2480.0**

FACTORY PRO TOOL



C-16185 C-16190

Pro Driver Set - Ti-Ni Coated

TEAM CORALLY - SHOCK PLIERS

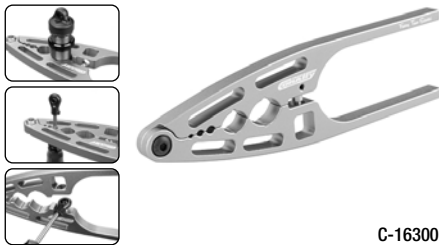

C-16300

Team Corally - Shock Pliers

PINION & PINION CADDY M1.0



Discover our range of Precision CNC-Cut MOD-1.0 Pinions and Pinion Caddy.

TEAM CORALLY - GREASE



Lithium Grease - Blue Grease - Ball Diff Grease - Copper Grease

TEAM CORALLY - SILICONE OILS



Shock Oils: 60ml - 150ml - CST or WT - 100 >1000 CPS
Diff Oils: 60ml - 2000 >2 000 000 CPS

TEAM PIT GEAR



A range of quality equipment for the transport and protection of your equipment.

SPORT RACING - LIPO

3S



C-49231-X

Team Corally - Sport Racing 50C - 5000MAH - 3S - 11,1V - XT-90 - Semi-Soft Case

SPORT RACING - LIPO

4S



C-49232-X

Team Corally - Sport Racing 50C - 5000MAH - 4S - 14,8V - XT-90 - Semi-Soft Case

SPORT RACING - LIPO

4S



C-49247-X

Team Corally - Sport Racing 50C - 7000Mah - 4S - 14,8V - XT-90 - Semi-Soft Case



Discover all these products and more on the website www.corally.com

Découvrez tous ces produits et bien plus encore sur le site web www.corally.com

Entdecken Sie all diese Produkte und mehr auf der Website www.corally.com

Ontdek al deze producten en meer op de website www.corally.com

WWW.CORALLY.COM

TEAM
CORALLY

WORLD CHAMPIONS



WWW.CORALLY.COM

Team Corally is a registered trademark licensed to
JSP Group Intl bvba • Geelseweg 80 • B-2250 OLEN • Belgium
Tel: +32 14 25 92 94 • Info@corally.com

This manual is an edition of Corally, a division of JSP GROUP INTL nv, Geelseweg 80, B-2250 Olen, Belgium. This manual is protected by a copyright and nothing from this edition may be reproduced or used without any prior written authorisation. Whilst every effort has been made to ensure the accuracy of the information in this manual, errors creep in and Corally can accept no responsibility for failures, wrong specifications, accuracy of colours, losses or damages caused. Corally denies any responsibility claims or damages caused by use of our products. Corally is not responsible for product / parts / specifications / Colour changes or availability of these products.