

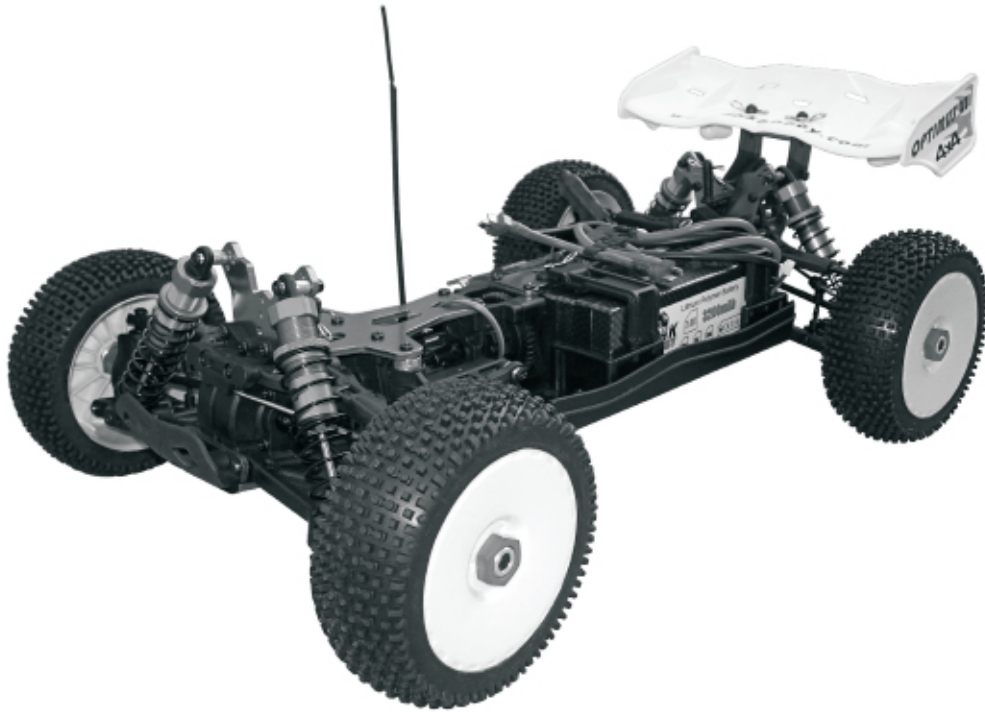

User's Instruction Manual



OPTIMUS XL

Model#: 8381

1/8 Scale 4WD Brushless Electric Buggy

Introduction

Thank you for choosing DHK's Optimus XL! This model is designed in thorough research and assembled with utmost craftsmanship. It is easy to drive and it uses quality parts and accessories to achieve best performance. It will bring you a lot of joy and fun when you drive this model.

Before starting to run the model, you are kindly requested to take some time to review this instruction manual for a better operation. This easy to follow instruction manual aims to provide a general guideline for end-users. Kindly note that a good understanding of the model, its relevant parts together with other accessories packed in this consumer box will enable you to have fun in driving. Meanwhile, users are recommended to conduct regular maintenance for a smooth performance. Failure to do so might shorten the lifespan of your model. You are cordially advised that DHK Hobby makes all necessary parts and accessories to support you for any problem during and after your driving.

Before you operate this radio controlled model, you must understand the following:

1. Make sure that all screws and nuts are tightened securely.
2. Make sure that the batteries are fresh or fully charged so the vehicle won't lose control.
3. Do not drive the model in the following places/areas to avoid injury of people and damage to the public property. Drive your model in open areas.
 - > On public streets or parks. Cause injury or death of pedestrians, young children, animals and pets.
 - > On highways. Cause accidents or damage of the model.
 - > In water. Cause damage to electronic components and parts, or direct failure of the model.
4. Check all signals and electronic parts are working properly.

After running, battery, ESC, and motor can be very hot. Make sure not to touch with bare hands.

Warning:

This high performance model can run very fast. It is designed and produced for people of 14+ years of age to operate. Entry level players should seek guidance and supervision from experienced model players. Players are responsible for any/all accidental occurrences (human or animal injury, damage to property and possessions, breakage of the model itself) due to improper operation of this model.

Model specifications

Overall length	: 19.4" (493.3mm)
Width	: 12.1" (307.7mm)
Height	: 6.76" (171.9mm)
Wheelbase	: 12.98" (330.1mm)
Ground clearance	: 1.36" (34.6mm)
Weight (net)	: 3.05kgs (6.8 LBs)
Front track/rear track	: 10.23" (260.0mm)/10.43" (265.0mm)
Tire diameter/width	: Ø4.6", 1.8" (Ø 118mm, 45mm)
Wheel diameter/width	: Ø3.2", 1.6" (Ø81mm, 42mm)
Gear ratio	: 10.68:1

Articles required to operate the model

4 pcs AA batteries (Ni-Mh or Ni-Cd rechargeable batteries, or non-rechargeable alkaline batteries) for 2.4GHz transmitter. Please refer to the 2.4GHz transmitter Instruction Manual.



Lipo balance charger (V3) (for 2S/3S Lipo battery) 500mAh output with AC input



2 Channel 2.4GHz radio system

OPTIMUS XL comes with a full function 2 channel 2.4GHz radio transmitter and receiver. Please refer to the 2.4GHz User's Instructions Manual for detail.

Brushless electronic speed control (ESC)

Optimus XL comes with 100A brushless electronic speed controller. Please refer to the instructions manual of the ESC for detail.

Brushless electric motor

3670 motor KV(RPM)	: 2030
Power	: 14.8V
Empty load current	: 4.0A(10V)
Resistance(Ω)	: 0.01 Ω
Length(including motor shaft)	: 85mm
Diameter	: 36mm
Weight	: 338g
Shaft diameter	: 5mm
Battery (Li-Po)	: 2-4S

Note:

When the motor temperature is over 120°C (248°F), please add a fan over the motor for better ventilation. Please refer to the parts list for the optional part motor cooling fan (Part#: P101).

9kgs Servo

Features	: Metal gears, ball bearings
Working voltage	: 6.0V
Speed (seconds/60 \circ)	: 0.16sec
Torque	: 9kg/cm (88.3Ncm)
Net weight	: 60g
Size(LxWxH)	: 55x21x43mm

Lipo Batteries

This buggy comes with duo 2S Lipo battery packs. Handling Lipo batteries should be very careful. Please read the following points with regard to charging and discharging Lipo batteries.

Charging the Lipo battery

Important warnings:

Be sure to follow these important warnings regarding the charging of Lipo batteries.

- > Never leave a Lipo battery unattended at any time while being charged.
- > Never charge a Lipo battery while it's inside the model. A hot pack could ignite wood, foam, plastic, etc.
- > Never charge Lipo battery with Ni-Mh or Ni-Cd peak charger. Only use a charger designed specifically for Lipo batteries which can apply the constant current/constant voltage charge technique.
- > Never charge Lipo battery at currents greater than the "1C" rating of the battery.
- > Never allow Lipo cells to overheat at any time. Cells which exceed 60°C (140°F) during charge can and usually will become damaged physically and possibly catch fire. Always inspect a battery which has previously overheated and do not re-use if you suspect it has been damaged in any way.
- > Always discontinue charging a Lipo immediately if at any time you witness smoke or see the battery starting to swell up. This may cause the battery to rupture and/or lead, and the reaction with air may cause the chemicals to ignite, resulting in fire. Disconnect the battery and leave it in a safe fireproof location for approximately 15 minutes.
- > Always charge a Lipo battery in a fireproof location, which could be a container made of metal, ceramic tile, or a bucket of sand.
- > Never allow a battery's positive and negative leads to accidentally touch each other. This will result in a short circuit and cause permanent damage to your battery and charger.

> Always monitor the battery and charger during the entire charge process. Never leave the battery and charger unattended during charge!

> Never continue to charge the Lipo batteries if the charger fails to recognize full charge. Overheating or swelling of the Lipo cells is an indication that a problem exists and the batteries should be disconnected from the charger immediately and placed in a fireproof location.

Discharging the Lipo battery

> Never leave a Lipo battery unattended at any time while being discharged.

> Always discharge Lipo batteries in a fireproof location, which could be a container made of metal or on ceramic tile.

> Always connect the battery's lead marked "Discharge" or "TO ESC" to the electronic speed controller. Never attempt to connect the battery's "CHARGE" lead to the ESC.

> It is strongly recommended to use an ESC which is designed to handle the low voltage cutoff points or Lipo batteries (Always follow the instructions provided with the ESC for proper operation). Discharging Lipo batteries below 2.5V per cell (Norm is 3.7V per cell, at 4.2V once fully charged) can cause permanent damage and limit the number of times the battery can effectively be used again.

> Never discharge Lipo batteries at currents which exceed the discharge current rating of the battery as this can often cause a cell to overheat. Do not allow a Lipo cell to exceed 60°C (140°F) during discharge.

Caution!

Cells may be hot. Do not allow the battery's internal electrolyte to get in the eyes or on skin. Wash affected areas with soap and water immediately if they come in contact with the electrolyte. If electrolyte makes contact with the eyes, flush with large amounts of water for 15 minutes and seek medical attention immediately.

Carefully inspect Lipo batteries which have been involved in a crash for even the smallest of cracks, splits, punctures or damage to the wiring and connectors.

Disposal of Lipo batteries

Unlike Ni-Cd batteries, Lithium-polymer batteries are environmentally friendly. For safety reasons, it's best that Lipo cells be fully discharged before disposal (however, if physically damaged it is not recommended to discharge Lipo cells before disposal). The batteries must also be cool before proceeding with disposal instructions. To dispose of Lipo cells and packs:

- > If any Lipo cell in the pack has been physically damaged, resulting in a swollen cell or a split or tear in a cell's foil covering, do not discharge the battery.
- > Place the Lipo battery in a fireproof container or bucket of sand.
- > Connect the battery to a Lipo discharger. Set the discharge cutoff voltage to the lowest possible value. Set the discharge current to a C/10 value, with "C" being the capacity rating of the pack.
- > Discharge the battery until its voltage reaches 1.0V per cell or lower. For resistive load type dischargers, discharge the battery for up to 24 hours.
- > Submerge the battery into bucket or tub of salt water. This container should have a lid, but it does not need to be air-tight. Perhaps a bucket or tub containing 3 to 5 gallons of cold water, and mix in 1/2 cup of salt per gallon of water. Drop the battery into the salt water. All the battery to remain in the tub of salt water for at least 2 weeks.
- > Remove the Lipo battery from the salt water and place it in the normal trash.

Parts List

Part#	Desc
8381-100	Assembly of diff gear box
8381-101	Diff set
8381-102	Diff outdrive/pins (dia 2*10mm)
8381-103	Pins(dia 2*10mm) (16 pcs)
8381-104	Flathead screw-coarse thread(KB2.6*10mm) (16 pcs)
8381-105	Crown gear-41T (large)/pinion gear-11T (small)
8381-106	Diff case set/diff case cover/diff gasket
8381-107	Washer-A/washer-B (8 pcs each)
8381-108	Gear-18T (2 pcs)/gear-12T (4 pcs)
8381-109	O Ring(dia 8mm*dia 2mm) (16 pcs)
8381-110	Ball bearing(dia 10mm*dia 15*4mm) (2 pcs)
8381-111	Diff pins(dia 4*25.8mm) (4 pcs)
8381-112	Assembly of the pinion gear
8381-113	Flathead screw(KM2.6X6mm) (16 pcs)
8381-114	Ball bearing(dia 8mm*dia 14*4mm) (2 pcs)
8381-115	Pins(dia 2*8mm) (16 pcs)
8381-116	Pinion gear outdrive/pins(dia 2*8mm)
8381-117	Ball bearing(dia 5mm*dia 11*4mm) (2 pcs)
8381-118	Diff gear box-F/R
8381-119	B head screw-coarse thread(BB3*16mm) (16 pcs)
8381-200	Central diff gear box(complete)
8381-201	Central diff set
8381-203T	Spur gear-43T(plastic) (1pcs)
8381-204	Set screws (M4*4mm) (16 pcs)
8381-206	Center diff gear box/center diff gear box plate
8381-207	B head screw-coarse thread(BB3*20mm) (16 pcs)
8381-208	Center outdrive set
8381-300	Shock absorber complete (aluminum) (2 pcs)
8381-301	Shock cap (2 pcs)
8381-302	Shock connecting rod-upper/lower/O ring (dia 12mm*dia 2mm)
8381-303	Shock adjust ring /O ring (dia 18.5mm*dia 1.5mm) (2 pcs)
8381-304	Shock body (2 pcs)
8381-305	Shock ball (8 pcs)
8381-306	M3 nylon nut (8 pcs)
8381-307	Lower shock mount/piston/O ring(dia 13mm*dia 1.5mm)
8381-308	O ring (16 pcs)
8381-309	Shock shaft (4 pcs)
8381-310	Shock spring (4 pcs)
8381-400	Anti-roll bar assembly
8381-40L	Assembly of anti-roll bar linkage-left
8381-40R	Assembly of anti-roll bar linkage-right

8381-401	Anti-roll bar rod end (8 pcs)
8381-402	Anti-roll bar linkage (4 pcs)
8381-403	Anti-roll bar pivot ball-upper/lower (4 sets)
8381-404	Set screws (M3*3mm) (8 pcs)
8381-405	Anti-roll bar(dia 2.2mm) (2 pcs)
8381-50L	Assembly of upper sus.arm-left
8381-50R	Assembly of upper sus.arm-right
8381-501	Upper sus.arm ball (4 pcs)
8381-502	Upper sus.arm/rod end (2 sets)
8381-503	Upper sus.arm linkage (2 pcs)
8381-600	Servo saver assembly-complete
8381-601	Brass washer (4 pcs)
8381-602	Servo saver bushing/adjustment ring
8381-603	Servo saver spring (4 pcs)
8381-604	Servo saver sus. Arm-upper/lower/steering sus. Arm
8381-605	B head screw-coarse thread(BB3*12mm) (16 pcs)
8381-607	Steering plate
8381-608	Shaft (2 pcs)
8381-609	Screw bushing (4pcs)
8381-6Z1	Steering linkage (2 pcs)
8381-6Z2	Plastic rod end (8 pcs)
8381-6Z3	Double way ball end (8 pcs)
8381-701T	Upper sus.arm mount-rear/suspension mount
8381-702	B head screw-coarse thread(BB3*14mm) (16 pcs)
8381-703	B head screw-coarse thread(BB3*10mm) (16 pcs)
8381-706	Lower sus.arm-front (2 pcs)
8381-708	Wheel axle (2 pcs)
8381-709	Steering arm (2 pcs)
8381-710	Ball bearing(dia 6mm * dia 12*4mm) (2 pcs)
8381-711	Hex adapter/M12 17mm nut
8381-729	Pins(dia 2*14mm) (16 pcs)
8381-713	B head screw(BM3*12mm) (16 pcs)
8381-714	C-hub (2 pcs)
8381-715	B head screw(BM3*20mm) (16 pcs)
8381-716	Set screws (M4*10mm) (16 pcs)
8381-717	Shock tower (2 pcs)
8381-718	Pivot ball mount (4 pcs)
8381-719	Upper sus.arm shaft (4 pcs)
8381-720T	Front bumper/upper sus.arm mount-front
8381-721	Lower sus.arm plate-front
8381-722	Tire complete (white rims) (2 pcs)
8381-723	C-hub screw bushings (16 pcs)
8381-724	T head hex screws (TM4*12mm) (16 pcs)
8381-726	B head screw-coarse thread(BB3*18mm) (16 pcs)

Part#	Desc
8381-728	B head screw(BM3*43mm) (8 pcs)
8381-735	Suspension Arm Shaft(2 pcs)
8381-801	Lower sus.arm-rear (2 pcs)
8381-802	Rear hub-L/R
8381-803	B head screw(BM3*18mm) (16 pcs)
8381-804	Wing mount/wing brace-L/R
8381-805	B head screw(BM3*10mm) (16 pcs)
8381-806	Rear wing rod-long/short
8381-807	Pin-A(dia 1.5mm) (16 pcs)
8381-808	Rear wing (white)
8381-9M1	Motor mount-upper/lower
8381-9M2	Motor gear-15T/set screw(M4*4mm)
8381-9S0	Assembly of 9kgs servo (with servo horns)
8381-9S1	Servo mount
8381-9S2	Servo arm (2 pcs)
8381-9S3	B head screw(BM3*6mm) (16 pcs)
8381-9Z0	Assembly of steering tie rod
8381-9Z1	Steering tie rod (2 pcs)
8381-001	Chassis
8381-002	Side guard-L/R
8381-003	Battery mount-F/R
8381-004	Upper deck mount-F/R
8381-005	Central drive shaft-F
8381-006	Central drive shaft-R
8381-007	Receiver cover-upper/lower
8381-008	Antenna tube (3pcs) Outer dia: 3.2mm, Internal dia: 2.0mm, Length: 12mm
8381-009	Pin-B(dia 1.2mm) (16 pcs)
8381-010	Screw washer(4 pcs)
8381-011	Flathead screw(KM3X10mm) (16 pcs)
8381-012	Flathead screw-coarse thread(KB3*10mm) (16 pcs)
8381-013	Flathead screw-coarse thread(KB3*12mm) (16 pcs)
8381-014	Flathead screw (KM3*5mm) (16 pcs)
8381-015	Flathead screw(KM3X18mm) (16 pcs)
8381-016	Upper deck-A
8381-017	Upper deck-B
8381-018	Body post-F/R/wire mount
8381-019	Battery cover/battery cover mount
8381-020	Hex driver H17 (Plastic)
8381-021	Painted body (PVC body)
8381-022	17mm nut (4 pcs/set)
8381-023	Painted body (PC body)

Part#	Desc
H140	Brushless ESC (100A)
H115	Brushless motor (KV:2030)
H103	LiPo battery (7.4V, 20C, 3200mAh)
P131	LiPo battery (7.4V, 20C, 2600mAh)
D301	Servo (9kg metal gears)
D302T	2 channel 2.4GHz transmitter
D302S	4 channel 2.4GHz receiver

Optional & Upgrade Parts

Part#	Desc
P101	Motor cooling fan/B head screw(BM4*17.5MM)
P102	Smart multi-functional charger & discharger
P103	LiPo battery (7.4V, 30C, 3200mAh)
D302HT	2 channel 2.4GHz LCD transmitter
P122	Central Diff Gear-43T (Zinc Alloy)
P124	Steering link
P125	Lower Suspension Arm (2 pcs)
P126	C-Hub (2 pcs)
P127	Suspension Mount (2 pcs)
P128	Left/Right Rear Hub
P129	Diff Case set/Diff Case Cover
P130	Front/Rear Diff Gear Box
8381-023C	Clear PC body

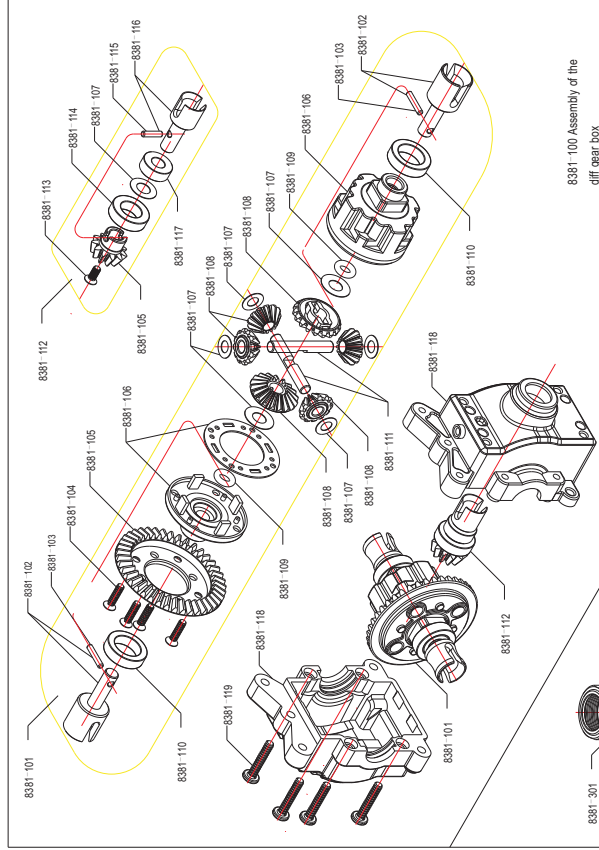

8381 110 Assembly of the diff gear box

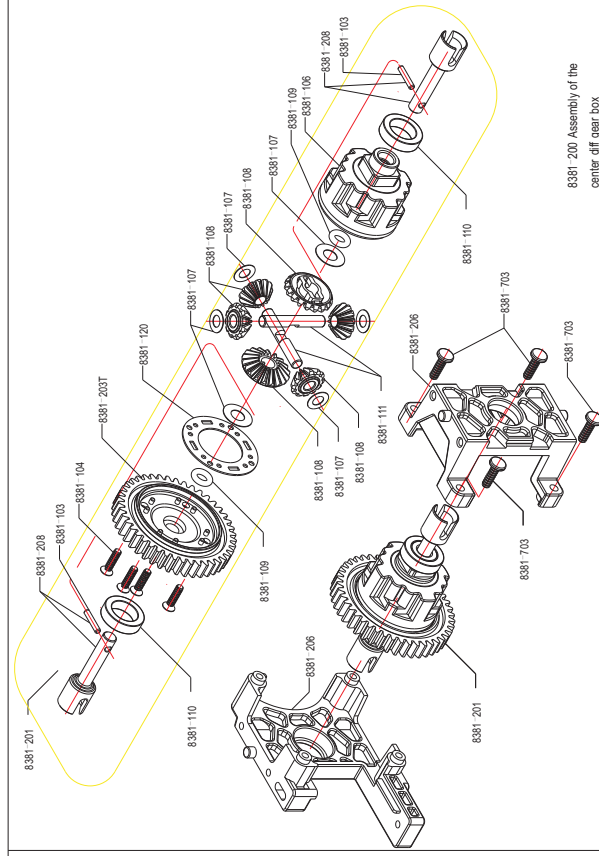

8381 200 Assembly of the center diff gear box

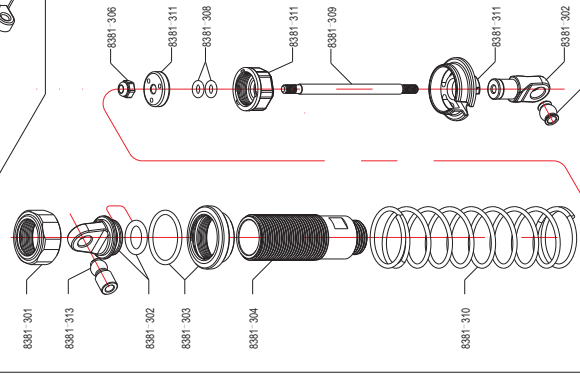

8381 300 Assembly of the struts

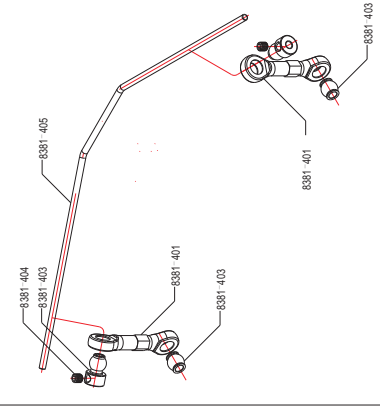

8381 400 Assembly of the sway bar

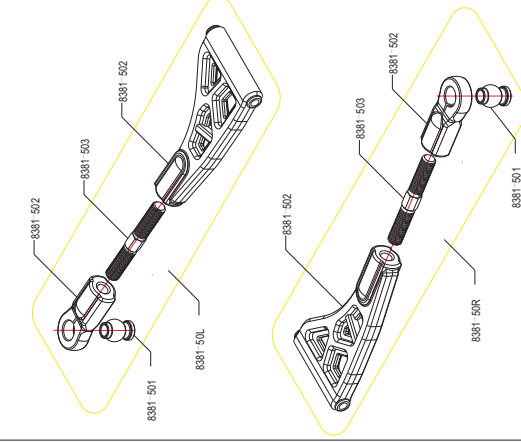

8381 50L Assembly of upper sus.arm Left
8381 50R Assembly of upper sus.arm Right

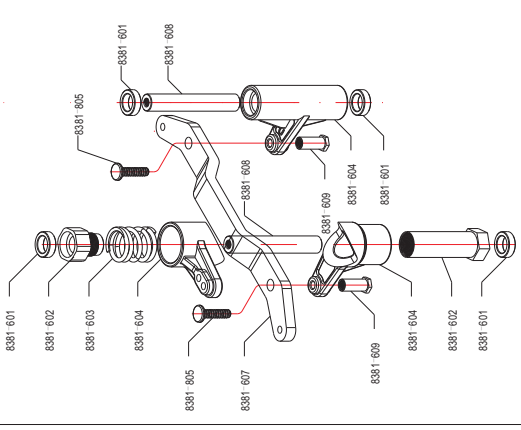

8381 600 Assembly of the servo saver

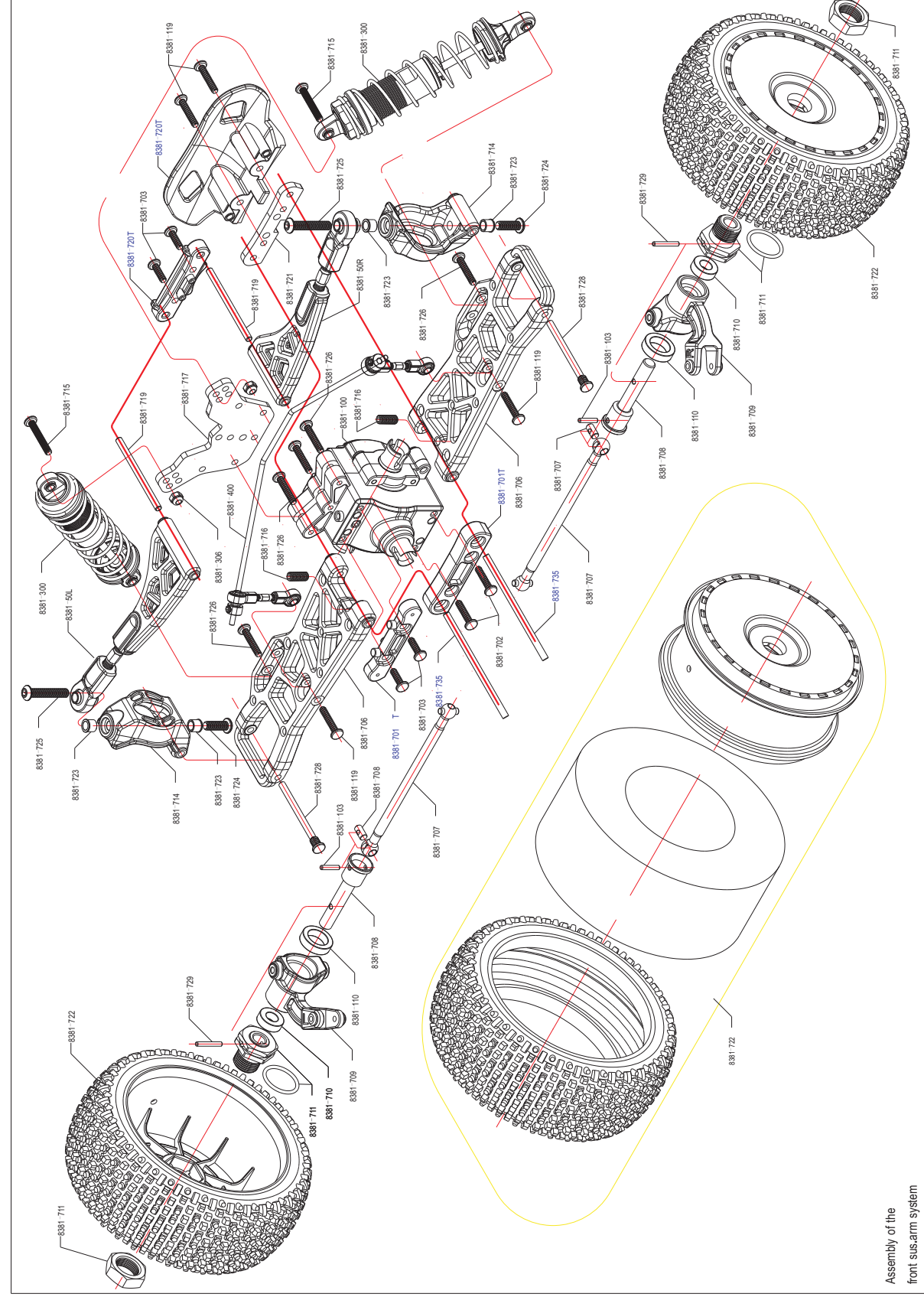

Assembly of the front sus.arm system

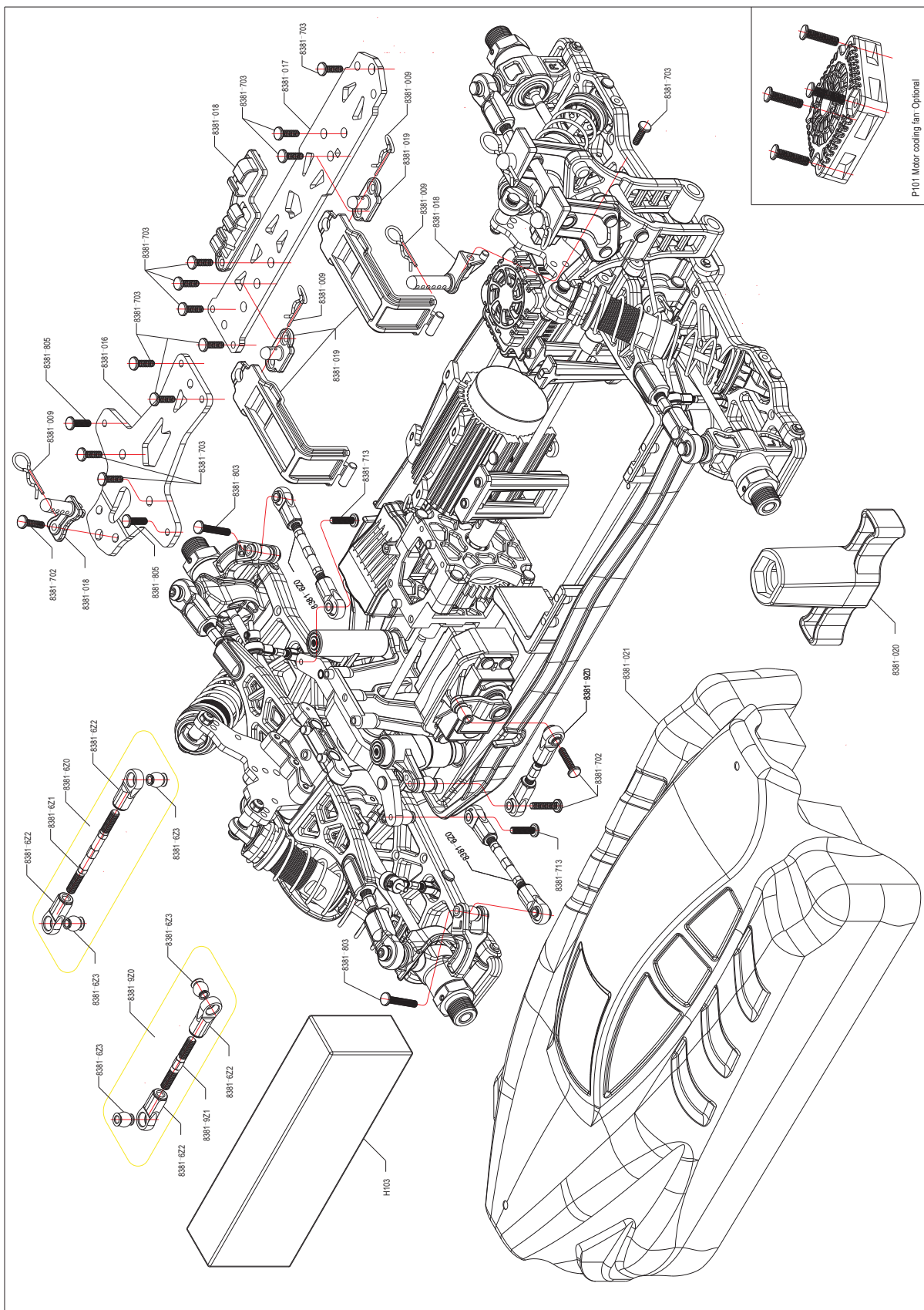

P101 Motor cooling fan Optional

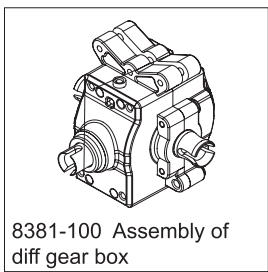

8381-100 Assembly of diff gear box

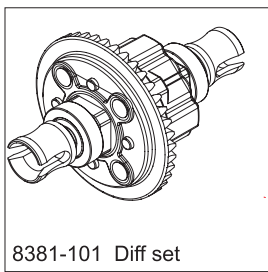

8381-101 Diff set

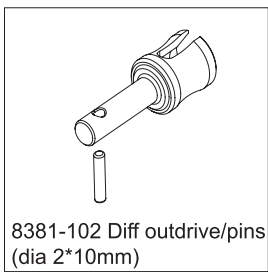

8381-102 Diff outride/pins (dia 2*10mm)

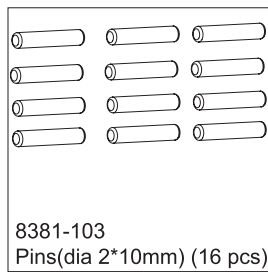

8381-103 Pins(dia 2*10mm) (16 pcs)

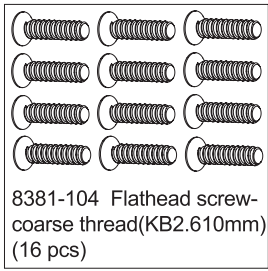

8381-104 Flathead screw-coarse thread(KB2.610mm) (16 pcs)

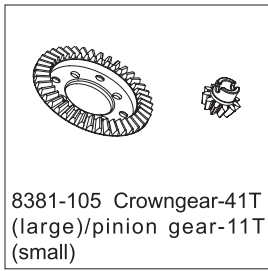

8381-105 Crowngear-41T (large)/pinion gear-11T (small)

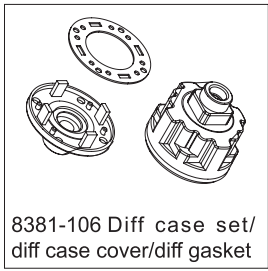

8381-106 Diff case set/ diff case cover/diff gasket

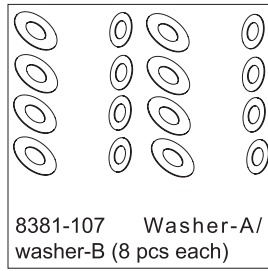

8381-107 Washer-A/ washer-B (8 pcs each)

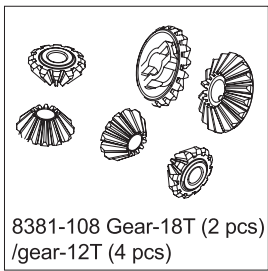

8381-108 Gear-18T (2 pcs) /gear-12T (4 pcs)

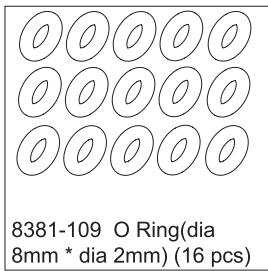

8381-109 O Ring(dia 8mm * dia 2mm) (16 pcs)

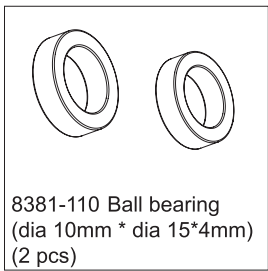

8381-110 Ball bearing (dia 10mm * dia 15*4mm) (2 pcs)

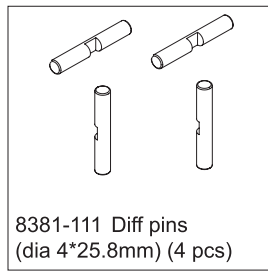

8381-111 Diff pins (dia 4*25.8mm) (4 pcs)

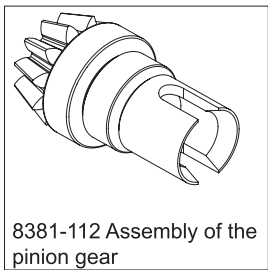

8381-112 Assembly of the pinion gear

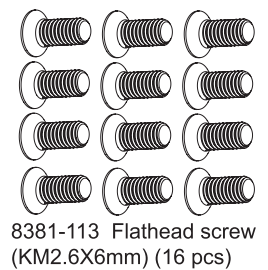

8381-113 Flathead screw (KM2.6X6mm) (16 pcs)

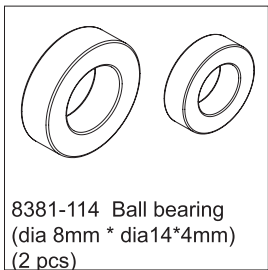

8381-114 Ball bearing (dia 8mm * dia14*4mm) (2 pcs)

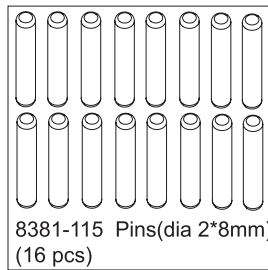

8381-115 Pins(dia 2*8mm) (16 pcs)



8381-116 Pinion gear outride/pins (dia 2*8mm)

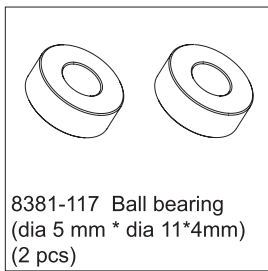

8381-117 Ball bearing (dia 5 mm * dia 11*4mm) (2 pcs)

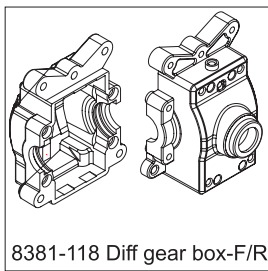

8381-118 Diff gear box-F/R

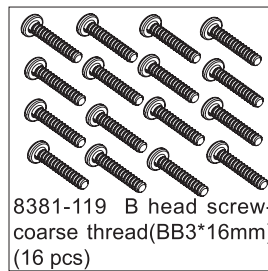

8381-119 B head screw-coarse thread(BB3*16mm) (16 pcs)

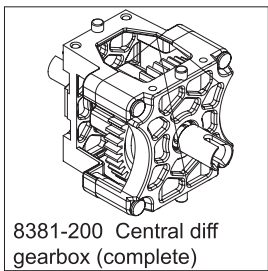

8381-200 Central diff gearbox (complete)

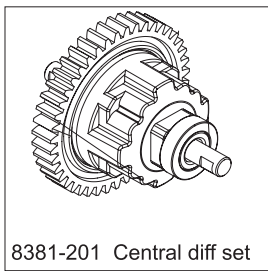

8381-201 Central diff set



8381-203T Spur gear-43T (plastic) (1pcs)

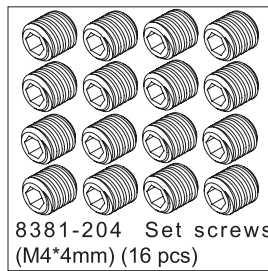

8381-204 Set screws (M4*4mm) (16 pcs)

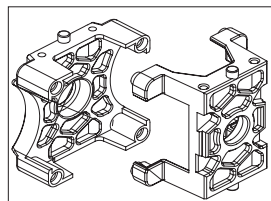

8381-206 Center diff gear box/center diff gear box plate

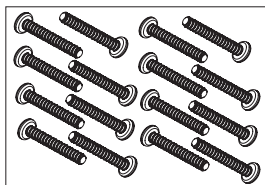

8381-207 B head screw-coarse thread (BB3*20mm) (16 pcs)

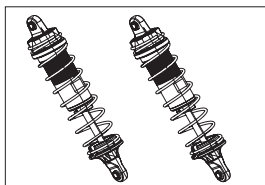

8381-300 Shock absorber complete (2 PCS)

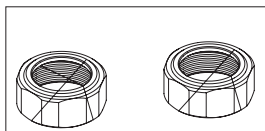

8381-301 Shock cap (2 pcs)

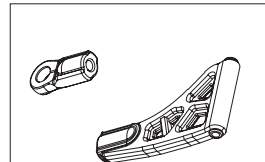

8381-502 Upper sus.arm/rod end (2 sets)

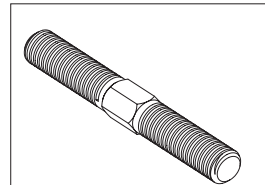

8381-503 Upper sus.arm linkage (2 pcs)

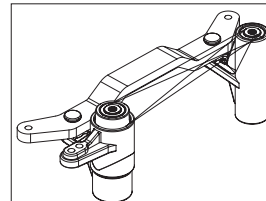

8381-600 Servo saver assembly-complete

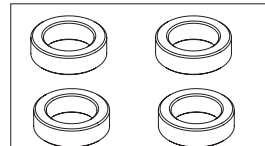

8381-601 Brass washer (4 pcs)

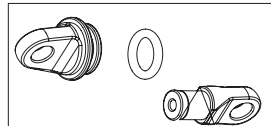

8381-302 Shock connecting rod-upper/lower/O ring (dia 12mm * dia 2mm)

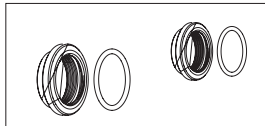

8381-303 Shock adjust ring /O ring (dia 18.5mm * dia 1.5mm) (2 pcs)

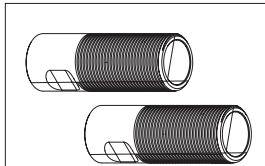

8381-304 Shock body (2 pcs)

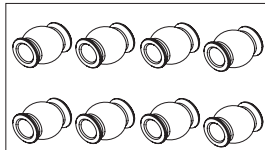

8381-305 Shock ball (8 pcs)

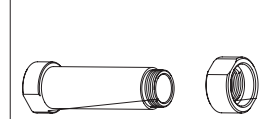

8381-602 Servo saver bushing/adjustment ring

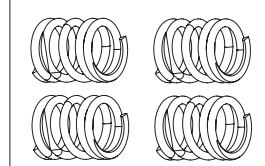

8381-603 Servo saver spring (4 pcs)

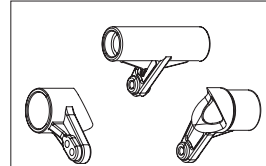

8381-604 Servo saver sus. Arm-upper/lower/steering sus. Arm

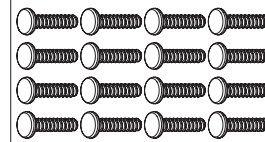

8381-605 B head screw-coarse thread(BB3*12mm) (16 pcs)

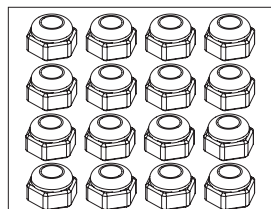

8381-306 M3 nylon nut (8 pcs)

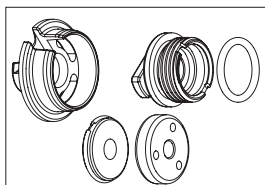

8381-307 Lower shock mount/piston/O ring (dia 13mm *dia 1.5mm)

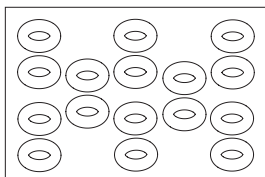

8381-308 O ring (16 pcs)

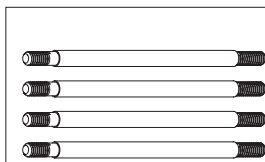

8381-309 Shock shaft (4 pcs)

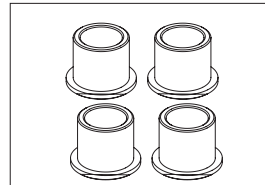

8381-609 Screw bushing (4 pcs)

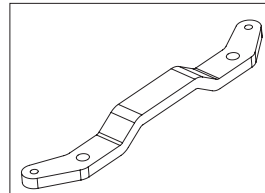

8381-607 Steering plate

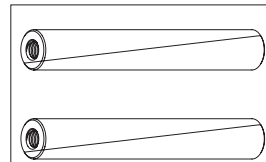

8381-608 Shaft (2 pcs)

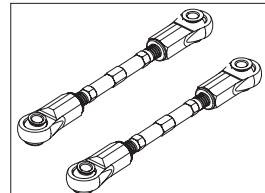

8381-6Z0 Assembly of steering linkage (2PCS)

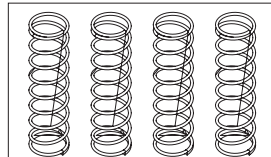

8381-310 Shock spring (4 pcs)

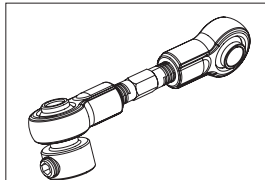

8381-40L Assembly of anti-roll bar linkage-Left

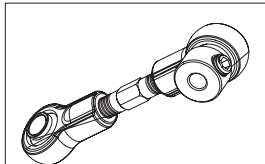

8381-40R Assembly of anti-roll bar linkage-Right

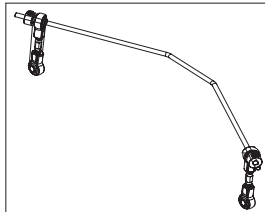

8381-400 Anti-roll bar assembly

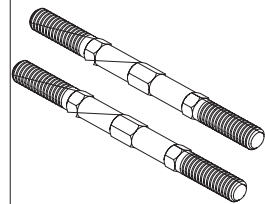

8381-6Z1 Steering linkage (2 pcs)

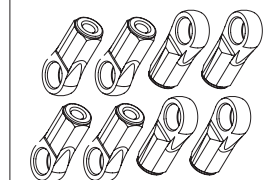

8381-6Z2 Plastic rod end (8 pcs)

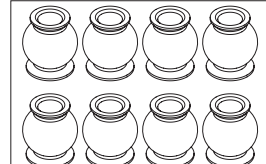

8381-6Z3 Double way ball end (8 pcs)

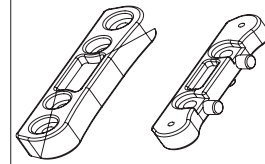

8381-701T Upper sus.arm mount-rear/suspension mount

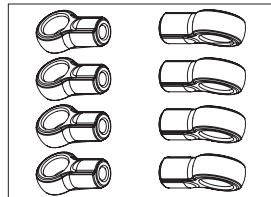

8381-401 Anti-roll bar rod end (8 pcs)

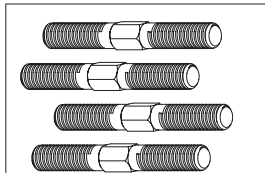

8381-402 Anti-roll bar linkage (4 pcs)

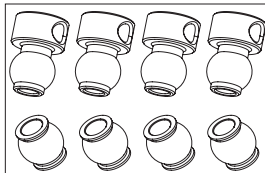

8381-403 Anti-roll bar pivot ball-upper/lower (4 sets)

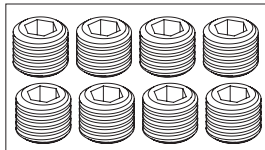

8381-404 Set screws (M3*3mm) (8 pcs)

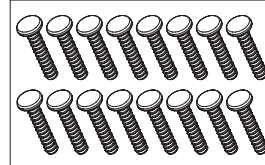

8381-702 B head screw-coarse thread(BB3*14mm) (16 pcs)

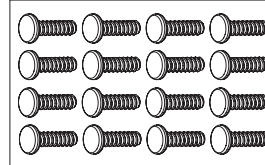

8381-703 B head screw-coarse thread(BB3*10mm) (16 pcs)



8381-735 Sus.arm shaft (2pcs)

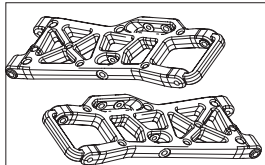

8381-706 Lower sus.arm-front (2 pcs)

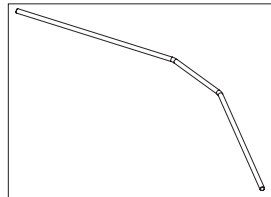

8381-405 Anti-roll bar (dia 2.2mm) (2 pcs)

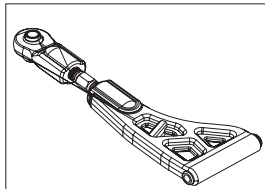

8381-50L Assembly of upper sus.arm-Left

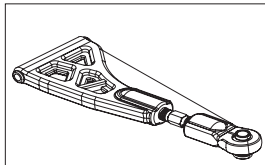

8381-50R Assembly of upper sus.arm-Right

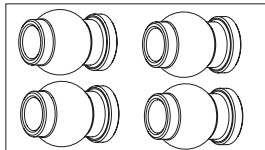

8381-501 Upper sus.arm ball (4 pcs)

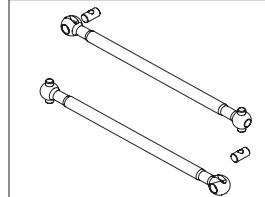

8381-707 Drive shaft set/revolving shaft (2 sets)

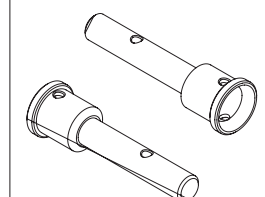

8381-708 Wheel axle (2 pcs)

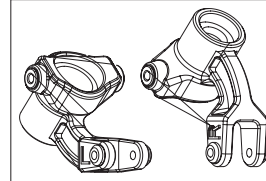

8381-709 Steering arm (2 pcs)

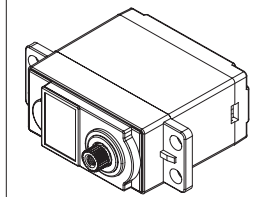

D301 Servo (9kg metal gears)

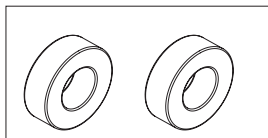

8381-710 Ball bearing(dia 6mm * dia 12*4mm) (2 pcs)

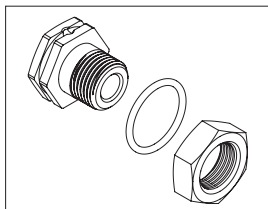

8381-711 Hex adapter/ M12 17mm nut

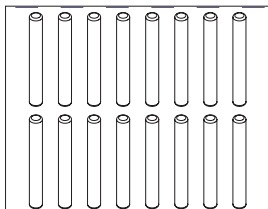

8381-729 Pins (dia 2*14mm) (16 pcs)

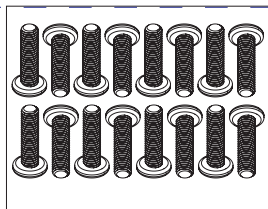

8381-713 B head screw (BM3*12mm) (16 pcs)

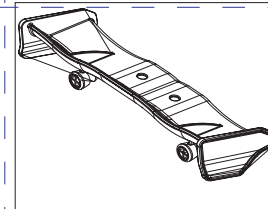

8381-808 Rear wing (white)

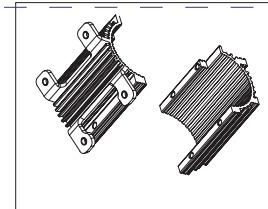

8381-9M1 Motor mount- Upper/Lower

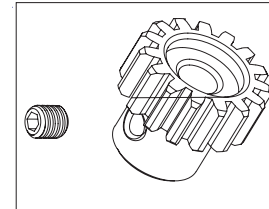

8381-9M2 Motor gear- 15T/set screw(M4*4mm)

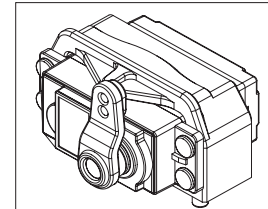

8381-9S0 Assembly of 9kgs servo (with servo horns)

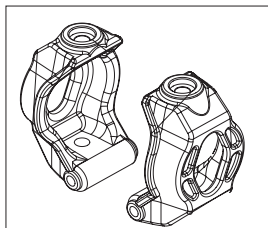

8381-714 C-hub (2 pcs)

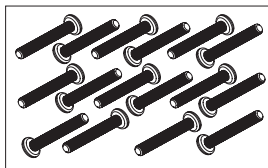

8381-715 B head screw (BM3*20mm)(16 pcs)

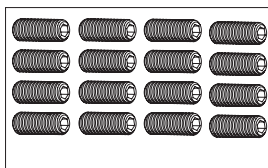

8381-716 Set screws (M4*10mm) (16 pcs)

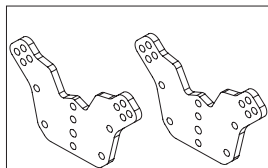

8381-717 Shock tower (2 pcs)

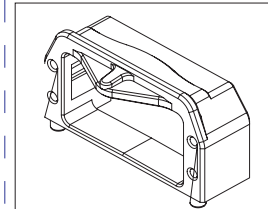

8381-9S1 Servo mount

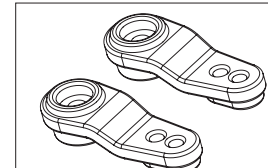

8381-9S2 Servo arm (2 pcs)

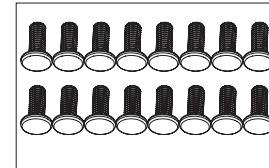

8381-9S3 B head screw (BM3*6mm) (16 pcs)

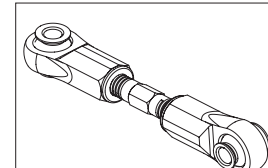

8381-9Z0 Assembly of steering tie rod

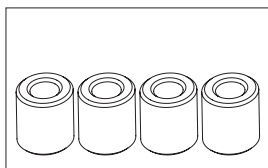

8381-718 Pivot ball mount (4 pcs)

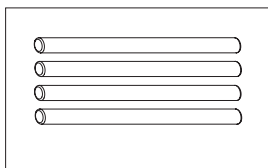

8381-719 Upper sus.arm shaft (4 pcs)

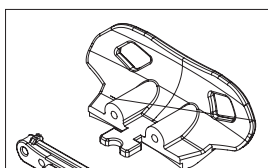

8381-720T Front bumper/ upper sus.arm mount-front

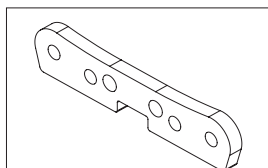

8381-721 Lower sus.arm plate-front

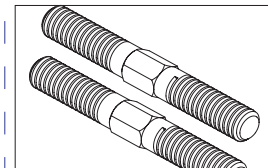

8381-9Z1 Steering tie rod (2 pcs)

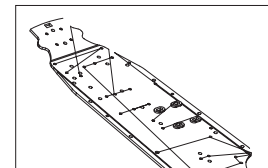

8381-001 Chassis

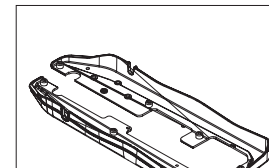

8381-002 Side guard-L/R

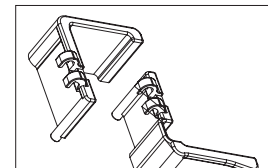

8381-003 Battery mount- F/R

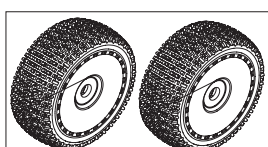

8381-722 Tire complete (white rims) (2 pcs)

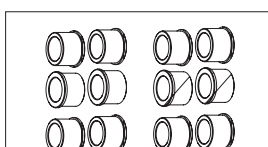

8381-723 C-hub screw bushing (16 pcs)

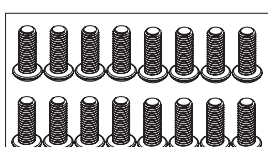

8381-724 T head screw (TM4*12mm) (16 pcs)

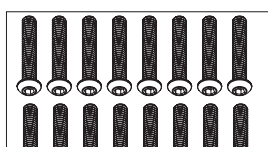

8381-725 T head screw (TM4*22mm) (16 pcs)

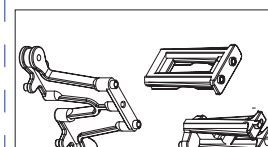

8381-004 Upper deck mount-F/R

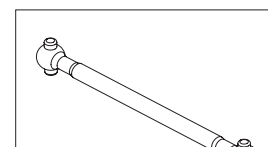

8381-005 Central drive shaft-A

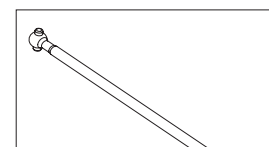

8381-006 Central drive shaft-B

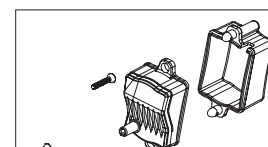

8381-007 Receiver cover- upper/lower

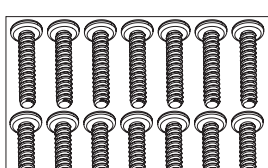

8381-726 B head screw- coarse thread(BB3*18mm) (16 pcs)

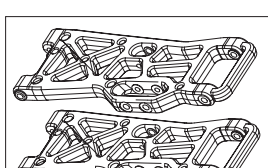

8381-801 Lower sus.arm- rear (2 pcs)

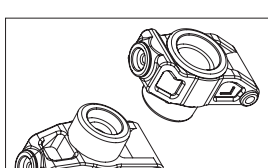

8381-802 Rear hub-L/R

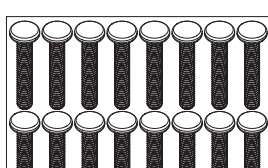

8381-803 B head screw (BM3*18mm) (16 pcs)

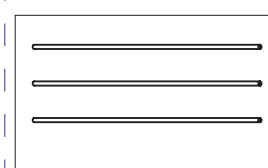

8381-008 Antenna tube (3 pcs)

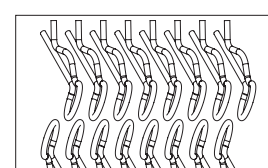

8381-009 Pin-B(dia 1.2mm) (16 pcs)

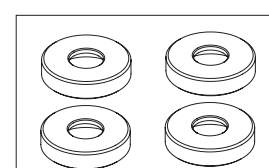

8381-010 Screw washer (4 pcs)

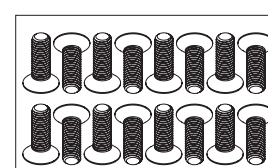

8381-011 Flathead screw (KM3X10mm) (16 pcs)

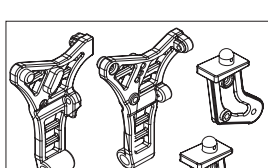

8381-804T Wing mount/ wing brace-L/R

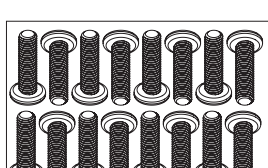

8381-805 B head screw (BM3*10mm)(16 pcs)

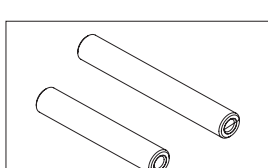

8381-806 Rear wing rod- long/short

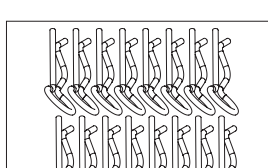

8381-807 Pin-A(dia 1.5mm) (16 pcs)

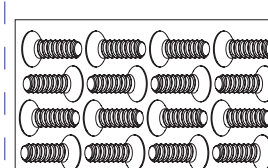

8381-012 Flathead screw- coarse thread (KB3*10mm) (16 pcs)

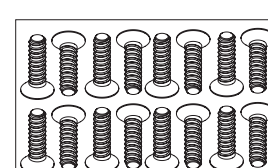

8381-013 Flathead screw- coarse thread (KB3*12mm) (16 pcs)

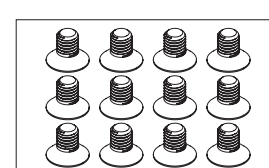

8381-014 Flathead screw (KM3*5mm) (16 pcs)

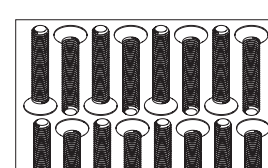

8381-015 Flatheadscrew (KM3X18mm)(16 pcs)

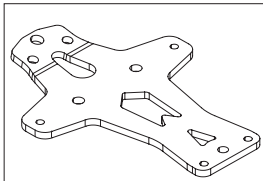

8381-016 Upper deck-A

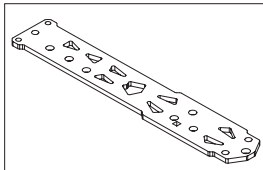

8381-017 Upper deck-B

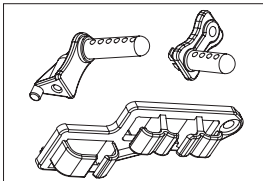

8381-018 Body post-F/R/wire mount-A

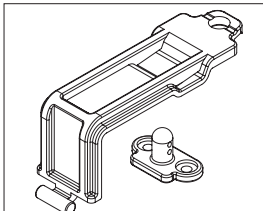

8381-019 Battery cover/battery cover mount

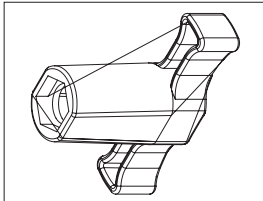

8381-020 Hex driver H17

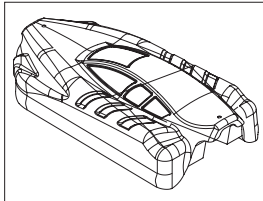

8381-021 Painted body (PVC body)

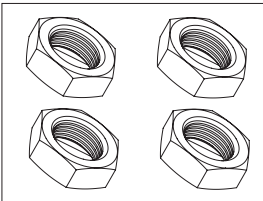

8381-022 17mm nut (4 pcs/set)

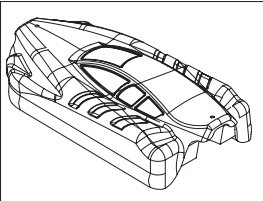

8381-023 Painted body (PC body)

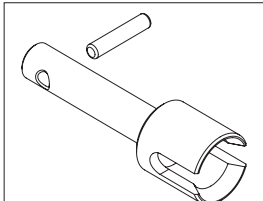

8381-208 Center outdrive set

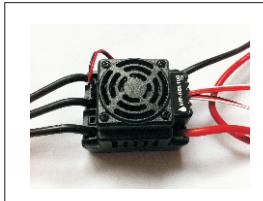

H140 Brushless ESC (100A)

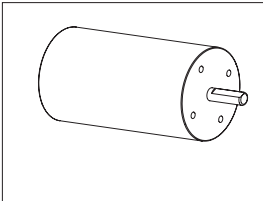

H115 Brushless motor (KV: 2030)

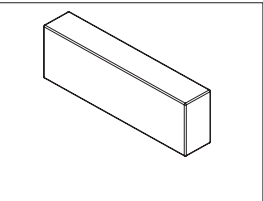

H103 LiPo battery (7.4V, 20C, 3200mAh)

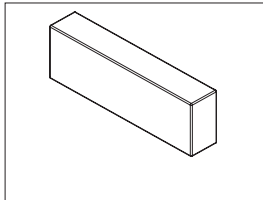

P131 LiPo battery (7.4V, 20C, 2600mAh)



D302T 2.4GHz Transmitter



D302S 4 channel 2.4GHz receiver

Optional & Upgrade Parts



P101 Motor cooling fan/B head screw(BM4*17.5mm)



P102 Smart multi-functional charger & discharger

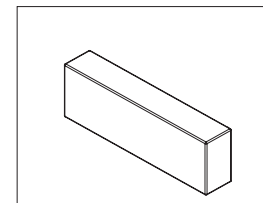

P103 LiPo battery (7.4V, 30C, 3200mAh)



D302HT 2.4GHz Transmitter with LCD Display



P122 Central Diff Gear-43T (Zinc Alloy)



P124 Steering link

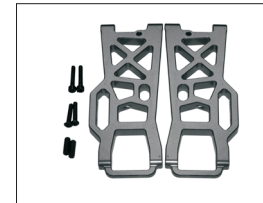

P125 Lower Suspension Arm (2 pcs)



P126 C-Hub (2 pcs)



P127 Suspension Mount (2 pcs)



P128 Left/Right Rear Hub



P129 Diff Case set/Diff Case Cover

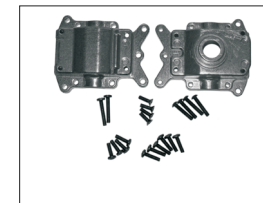

P130 Front/Rear Diff Gear Box

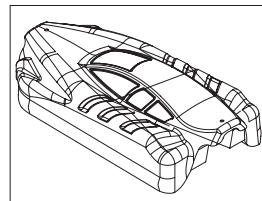

8381-023C Clear PC body

Annex: 2.4GHz Transmitter Manual

PART I:

2.4GHz Transmitter (Standard, Model#: D302T)

Safety Precautions

- 1.The 2.4GHz transmitter and receiver are pre-bound at the factory.
- 2.Please always use the same receiver model from the factory to match your 2.4GHz transmitter when you need to replace it. Receivers from other suppliers don't work on DHK HOBBY 2.4GHz transmitter.
- 3.When you need to replace a receiver, please make sure that it is bound with the transmitter before use.
- 4.Please operate the transmitter in vast areas where no radio interference exists. It's strongly recommended that no humans, animals or high voltage grid should be nearby.
- 5.Please do not operate this transmitter during fatigue, sickness, intoxication or in bad mood.
- 6.Do not operate the transmitter at night time, in the rain and thunderstorm or at low visibility.
- 7.Always use the same types of batteries in the transmitter Do not mix old and new batteries in the transmitter. Please check the battery power before use. Replace batteries whenever the power is low to avoid out of control. Ni-Mh or Ni-Cd rechargeable batteries can be used on this transmitter. Please charge the batteries to full before use.
- 8.Before you operate the transmitter, please check the switch, batteries, servo and ESC for proper connection.
9. ALWAYS switch on the transmitter first, and off last so as to avoid possible radio interference from other sources. Failure to do so may cause out of control of your vehicle.
- 10.Before operation, check the servo forward and reverse functions, motor range, and neutral position. Modify it when necessary.
- 11.Please handle the transmitter with care. Store the transmitter in a dry and clean place when it's not in use for some time.

Transmitter Specifications

Channels	2 channels	Channel resolution	4096
Model types	Cars, boats	Remote range	>200M
Frequency range	2.40-2.483GHz	TH range	0.9mS-2.1mS
RF power	≤20dB	ST range	0.9mS-2.1mS
Power output	10mW	Battery voltage	6V (1.5V*4 cells)
Bandwidth	1M	Low voltage protection	≤4.4V
Band number	64	Weight	320g
2.4GHz modulation	AFHDS	USB port	N/A
Encoding	GFSK	Charging port	Yes

2.4GHz Standard Transmitter Parts and Functions

- 1-Antenna: pull up the antenna straight before use.
- 2-Power switch: slide the switch to turn on or off.
- 3-Power LED: shows the power strength. Green LED shows full power, Yellow LED flashes when the power is running short.
- 4-Charging port: charges Ni-Mh or Ni-Cd batteries only. Alkaline batteries are not rechargeable. NEVER charge your alkaline batteries.
- 5-Throttle trigger: Please refer to the transmitter diagram.
- 6-Steering wheel: Please refer to the transmitter diagram.
- 7-ST-D/R trim: adjust the steering servo angle ranging from 0% to 120%.
- 8-TH-D/R trim: adjust the throttle servo angle ranging from 0% to 120%.
- 9-ST-TRIM: adjust the steering neutral position, from 0% to 20%.
- 10-TH-TRIM: adjust the throttle neutral position, from 0% to 20%.
- 11-ST-NOR/REV: slide to left or right to choose steering mode.
- 12-TH-NOR/REV: push the trigger or pull it back to choose the throttle mode.
- 13-Throttle trigger trim screws: use a hex driver to tighten or loosen the screw to a comfortable level.
- 14-Battery compartment cover: to open the compartment, slide the cover to OPEN direction as indicated, snap it to close the compartment.
- 15-Battery case: open the battery cover, install 4 pcs AA 1.5V alkaline or rechargeable batteries based on the "+" & "-" poles. If the status LED flashes red, the transmitter batteries may be weak, discharged or possibly installed incorrectly. Replace with new or freshly charged batteries. The power indicator light does not indicate the charge level of the battery pack installed in the model.

Parts Diagrams

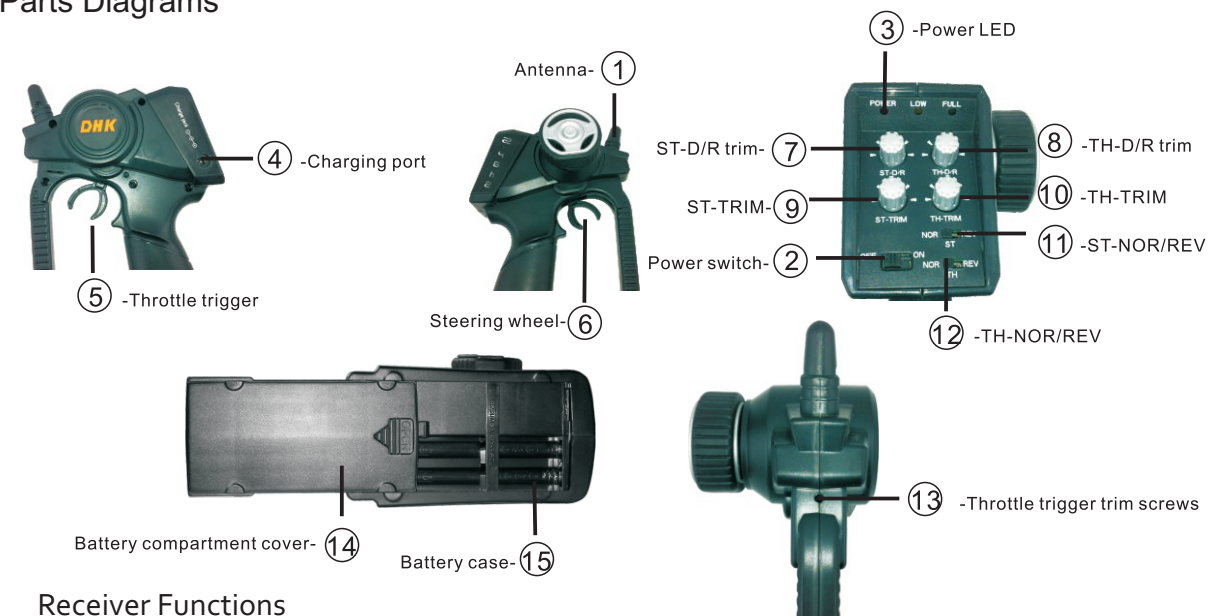

Receiver Functions



Frequency range	: 2.4GHz
2.4GHz modulation	: AFHDS
Sensitivity	: -100dbm
Working voltage	: DC4.8 -6.0V
Working current	: ≤25mA
Size	: 5.7*26*15.2mm
Weight	: 11.2g

1. Antenna: Pull out the antenna completely

2. Connecting ports: receiver power port and channel signal connecting ports

> ST/1: Channel 1, steering signal port

> TH/2: Channel 2, throttle servo or ESC signal port

> AUX/3: Auxiliary signal port

> BATT/4: Receiver power port, can be auxiliary signal port

3. Set keys & LED indicators

>Bind setup. Switch on the receiver, indicators flash slowly, press the setup key for 2 seconds and release it, LED indicator flash in faster motion, binding starts. When the LED indicator is on in stable status, the binding is complete. Note: To bind it quickly and effectively, please put the receiver 40-50cm away from the transmitter.

>Failsafe. Switch on the transmitter and receiver, then you can see the LED indicator on receiver is on. Adjust the throttle servo or ESC to brake or stop status, and keep it that way. Press the setup key, then receiver LED indicator flashes, keep this for 3 seconds. After this, release the setup key. Failsafe setup is complete.

>Disabling failsafe function. Switch on transmitter and receiver, once the signal is connected, LED indicator is on. Press the setup key for 2 seconds, LED indicator flashes quickly, at this point, keep pressing the setup key without release, press it for 2 more seconds, LED indicator flashes slowly. Release the setup key, LED indicator is on. The setup is complete.

PART II:

2.4GHz Transmitter (LCD Version, Model#: D302HT)

Safety Precautions

Please refer to Safety Precautions in PART I

Transmitter Specifications

Please refer to Transmitter Specifications in PART I.

2.4GHz LCD Transmitter Parts and Functions

1. 2.4G transmitter antenna: before use, please pull the antenna straight up.

2. Power switch: Press down to turn on the transmitter, press the switch again to turn it off.

3. LCD display: shows transmitter menus, parameters and operation instructions.

4. Charging port: charging area is positive inside and negative outside. When Ni-Mh or Ni-Cd rechargeable batteries are to be charged, right charger should be selected for re-charging the batteries.

5. Throttle trigger: drag, push or make the throttle trigger to a neutral position to forward, reverse or brake your RC model.

6. Steering wheel: turn the steering wheel counterclockwise to turn the model to left. Turn the steering wheel clockwise to turn the model to right. Release it to neutral for straight driving.

7. Menu keys: Press Left key (<) or Right key (>), move the cursor to LCD display options.

8. DATA change keys: press Left key (+) or Right key (-) to change, adjust and save current parameters.

9. Throttle trigger set screw: use a 2.5mm hex screw driver to move forward or backward to adjust the throttle trigger to a comfortable hand feeling.

10. Battery compartment cover: Press the door to OPEN indicated direction to open the battery compartment cover. Snap the compartment door into the slot to close the battery compartment.

11. Installing batteries: open the battery compartment cover, install 4 pcs 2AA batteries (same type) according to the indicated +? ?-? orientations. Turn on the transmitter and check the indicator status for a solid green light. Please take out the batteries when the transmitter is not in use. If the status LED flashes red, the transmitter batteries may be weak, discharged or possibly installed incorrectly. Replace with new or freshly charged batteries. The power indicator light does not indicate the charge level of the battery pack installed in the model.

Parts Diagrams

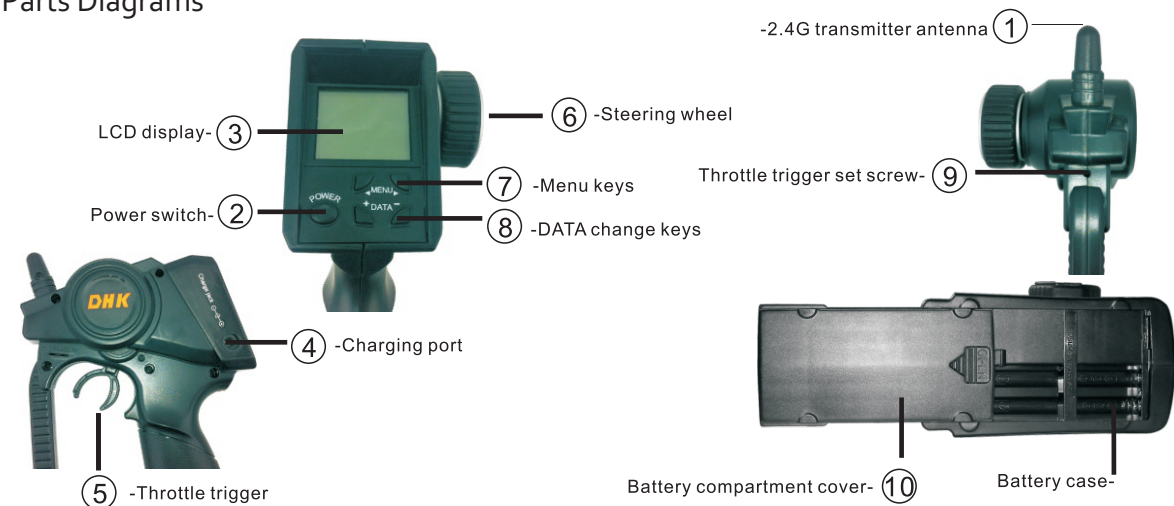

LCD Functions and Operations

Key Operations



Menu keys:

Press Left key (<) to main command, and Right key (>) for secondary command.

DATA keys:

Press Left key (+) or Right key (-) to adjust, set up and auto save the current chosen function.

Display Interface



Switch on the transmitter, you will hear ?beep? sound (beeps once), and the LCD display mode will read the default parameters pre-set at the factory and BATT status mode (main menu).

BATT: battery status, function reset settings

Battery level display. Battery voltage appears on LCD display. When the voltage is 4.4V, the value flashes and you can hear warning sound. This means the battery voltage is deficient. When battery voltage value shows 4.0V, the value blinks fast and warning sound keeps strong. This indicates battery voltage is too low and batteries cannot be used. Please turn off the transmitter and replace batteries. If rechargeable Ni-Mh or Ni-Cd batteries are used, please charge the batteries with proper charger.

Function reposition. In case the parameters are messed up or if you don't know how to set up, please turn off the power, press and hold MENU Left key (<). Then turn on the power and you will hear ?beep? sound after two seconds. Release all keys and all parameters will go back to factory default values.

Frequency duplication setting. When two transmitters are used at the same time, a frequency might be duplicated. In this case, you may choose the auto frequency function. First turn-off the power, then press and hold MENU Right key (>), and turn on the power. The display will show hopping data. Release the key and the hopping data will stop. The digit shown on the display is your frequency. Bind the transmitter with the receiver through binding keys.

MOD: Setting up mode and naming

15 group memory data for choice, it's easy to manage and use. At start status, press Left key (+) or Right key (-) of the DATA to choose the necessary module (Screen shows main menu)

For easy control, you may name each module. Press Left key (<) on MENU (6 times on Main Menu) until you see 000 01 on the screen and the first digit must flash, at this moment, you may change the data here. Press Left key (+) or Right key (-) to choose necessary data. Once first change is made, press Right key (>) on MENU to move the cursor to the next position, then press Left key (-) or Right key (+) to choose the needed data. Based on the above, you can change data for the 3rd data group. Once all is changed, press Left key (<) on the MENU function to get back to Main Menu and save the setup. (Screen shows 000 01).

MOD	Range	Default
MODULE	0 - 15	01
NAMING UNITS	Digits 0-9, letters A-Z	000

REV: Servo forward and reverse setup

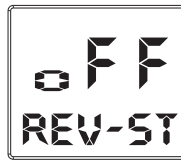

Setting up Steering servo direction. Press MENU function Left key (<) or Right key (>) (Press once under MAIN MENU) until you see? ***REV-ST?, then press DATA function Left key (+) or Right key (-) to choose ON/OFF. (Screen shows OFF REV-ST).

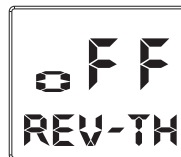

Setting up Throttle speed neutral position. Press MENU function Left key (<) (Press once under the MAIN MENU) and then press twice of MENU Right key (>) until you see ***REV-TH. Press DATA function Left key (+) or Right key (-) ON/OFF. (Screen shows OFF REV-TH).



Setting up the 3rd **Channel**: Press MENU function Left key (<) (Press once under MAIN MENU), then press twice on Menu function Right key (>) until you see ***REV-3C, press DATA function Left key (+) or Right key (-) to choose ON/OFF. (Screen shows OFF REV-3C).

REV	Initial value	Range
ST	OFF	ON/OFF
TH	OFF	ON/OFF
3C	OFF	ON/OFF

TRM: Servo neutral trim setup

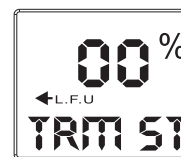

Setting up steering servo(ST) neutral position parameters. Press MENU function Left key (<) (Press twice under MAIN MENU) until you see **% TRM ST and neutral value. Press DATA function Left key (+) or Right key (-) to change the steering neutral position. On the screen there is steering neutral status L.F.U, R. B. D and percentage values indicating the neutral position at that setup. (Screen shows 00% TRM ST).

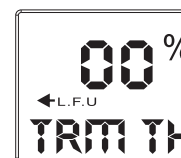

Setting up throttle speed (TH) neutral position parameters. Press MENU function Left key (<) (Press twice under MAIN MENU), and press MENU function Right key (>) until you see **% TRM TH and neutral value. At this point, press DATA function Left key (+) or Right key (-) for adjustment. On the screen you will see neutral position status indicator L. F. U, R. B. D and percentage values. (Screen shows 00% TRM TH)

TRM	Initial value	Range
ST	0%	100%<--L. F. U—100% R.B.D.-->
TH	0%	100%<--L. F. U—100% R.B.D.-->

D/R: Servo angle adjustment setup



Set up Steering servo (ST) angle. Press Menu function Left key (<) (Press 3 times on MAIN MENU) until you see **% D/R ST on the screen, then press DATA function Left key (+) or Right key (-) to choose servo angle parameter. (Screen shows 100% D/R ST).



Set up Throttle servo (TH) forward and reverse angle. Press MENU function Left key (<) (Press 3 times on MAIN MENU), then press MENU function Right key (>) once, the screen shows **% D/R TH, press DATA function Left key (+) or Right key (-) for throttle angle parameters. (Screen shows 100% D/R TH)

D/R	Initial value	Range
ST	100%	0% - 100%
TH	100%	0% - 100%

EPA: End point adjustment (servo single side angle setup)



Set up steering servo single side (left steering or right steering) travel **angle**. Press MENU function Left key (<) (Press 4 times under MAIN MENU) until the screen shows **% EPA ST. Turn the steering wheel clockwise, the screen shows the EPA value of right steering R.B.D.-->; Press DATA function Left key (+) or Right key (-) and change the data. When you turn the steering wheel counterclockwise, the screen displays the EPA value of left steering L. F. U on steering servo. Press DATA function Left key (+) or Right key (-) for desired value. (Screen shows 100% EPA-ST)



Note: for this function, the steering servo travel angle is adjusted to a wider or narrower range, hence the steering angle of the left or right tire is adjusted to desired angle.

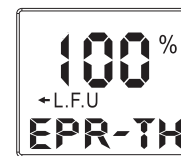

Set up throttle speed (forward or reverse). Press MENU function Left key (<) (Press 4 times under MAIN MENU) and press once on MENU function Right key (>), the screen shows **% EPA TH. Pull back the throttle trigger and the screen displays L.F.U value of forward (F) speed. Press DATA function Left key (+) or Right key (-) to change the value. Push forward the throttle trigger and the screen shows reverse R.B.D value of reverse speed, press DATA function Left key (+) or Right key (-) to change the value. (Screen shows 100% EPA-ST)



Note: for this function, the throttle servo angle is adjusted (wider or narrower) on nitro- (gas-) powered vehicles, and for EP vehicles, speed of the electronic speed controller adjusted (faster or slower).

EPA	Initial value	Range
ST←L.F.U	100%	0% - 120%
ST R.B.D→	100%	0% - 120%
TH←L.F.U	100%	0% - 120%
TH R.B.D→	100%	0% - 120%

ABS: Setting up brake system

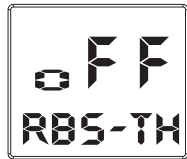

Set up throttle ABS brake system. Press MENU function Left key (<) (Press 5 times under MAIN MENU), screen shows *** ABS- TH, press DATA function Left key (+) or Right key (-) to choose ON/OFF. At ON status, it prevents the tires from getting stuck in powerful griping motion during brake. (Screen shows *** ABS- TH)

For each of the above setup, when one setting is selected, please wait for 5 seconds until you see the main menu, then that setting is automatically saved as memory.

Receiver Functions

Please refer to Receiver Functions Section in PART I.

FCC Caution: Any changes or modifications not expressly approved by the party responsible for compliance could void the user's authority to operation this equipment. This device complies with Part 15 of the FCC Rules. Operation is subject to the this device must accept any interference received, including interference that may cause undesired operation . This device and its antenna(s) must not be co-located or operating in conjunction with any other antenna or transmitter.

TCB

GRANT OF EQUIPMENT
AUTHORIZATION
Certification
Issued Under the Authority of the
Federal Communications Commission
By:

TCB

PHOENIX TESTLAB GmbH
Koenigswinkel 10
D-32825 Blomberg,
Germany

Date of Grant: 11/20/2012
Application Dated: 11/20/2012

DHK TECHNOLOGY CO., LTD.
E2 BLDG, WANFENG WESTERN IND ZONE, HEYI, SHAJING
SHENZHEN, 518104
China

Attention: Jack Jiang , Manger

NOT TRANSFERABLE

EQUIPMENT AUTHORIZATION IS HEREBY ISSUED TO THE NAMED GRANTEE, AND IS VALID ONLY FOR THE EQUIPMENT IDENTIFIED HEREON FOR USE UNDER THE COMMISSION'S RULES AND REGULATIONS LISTED BELOW.

FCC IDENTIFIER: QUCD302T-D302HT
Name of Grantee: DHK TECHNOLOGY CO., LTD.
Equipment Class: Part 15 Low Power Communication Device
Transmitter
Notes: 2.4GHz Transmitter

Grant Notes

FCC Rule Parts
15C

Frequency Range (MHZ)
2402.0 - 2474.0

Output Watts

Frequency Tolerance

Emission Designator



Shenzhen Bontek Electronic Technology Co., Ltd.

CE Attestation of Conformity

Certification number: BCT11GC-1068E Report number: BCT11GR-1068E-1, BCT11GR-1068E-2

Shenzhen Bontek Electronic Technology Co., Ltd. hereby declares that testing has been completed and reports have been generated for:

Applicant: DHK TECHNOLOGY CO. LTD.
E2 Bldg, Wanfeng Western Ind Zone, Heyi, Shajing, Shenzhen, China 518104

Manufacturer: DHK TECHNOLOGY CO. LTD.
E2 Bldg, Wanfeng Western Ind Zone, Heyi, Shajing, Shenzhen, China 518104

Trade Mark: DHK HOBBY

Product: 2.4GHz Transmitter & Receiver

Model: D302T, D302HT

And, in accordance to the following applicable directives:

1999/5/EC R&TTE Directive (as amended)

That this product has been assessed against the following applicable Standards;

R&TTE

ETSI EN 300 440-1 V1.6.1
ETSI EN 300 440-2 V1.4.1
ETSI EN 301 489-1 V1.8.1
ETSI EN 301 489-3 V1.4.1

Therefore, SHENZHEN BONTEK ELECTRONIC TECHNOLOGY CO., LTD. hereby acknowledges that the Manufacturer may issue a DECLARATION of CONFORMITY and apply the CE mark in accordance to European Union Rules.

Attestation by:

Kendy Wang



Date of Issued: Sep. 5, 2011

1/F, Block East H-3, OCT Eastern Ind. Zone, Qiaocheng East Road, Nanshan, Shenzhen, China
Tel: +86-755-86337020 Fax: 86-755-86337028 http://www.bontek.com.cn



CERTIFICATE Of Conformity

Certificate No.	: USG2013112501C-E
Applicant	: Shenzhen Surpass Tech Co.,Ltd. Egong Ridge, Pinhu Town, Longgang Dist. Shenzhen Guangdong 518111 CHINA
Manufacturer	: Shenzhen Surpass Tech Co.,Ltd. Egong Ridge, Pinhu Town, Longgang Dist. Shenzhen Guangdong 518111 CHINA
Product	: brushless motor
M/N	: 540、550、2030、2040、2845、2850、2860、3650、3655、3660、3665、3674、4068、4076、4082、4092、5693、56113
Trademark	
Test Standard	: EN 60034-1 EN 61000-3-2 EN 61000-3-3 EN 55014-1 EN 55014-2

The EUT described above has been tested by us with the listed standards and found in compliance with the council EMC directive 2006/95/EC(73/23/EEC)2004/108/EC. It is possible to use CE marking to demonstrate the compliance with this EMC Directive. The certificate applies to the tested sample above mentioned only and shall not imply an assessment of the whole production. It is only valid in connection with the test report number: USG2013112501R-E.



Date: Nov. 25. 2013

Shenzhen USG Technology Co.,Ltd

Block A, Anle Industrial Zone, Hangcheng Road, Xixiang Town, Shenzhen, China
Tel: 86-755-26458601 Fax: 86-755-61653962 www.szdezhuo.com

DHK TECHNOLOGY CO.LTD.

E2 Blk, Wan'feng Western Ind Zone,
Heyi, Shenzhen, China 518104
Phone:+86 755 33895639
Fax:+86 755 33895635
email:dhkhobby@yahoo.com
<http://www.dhkhobby.com>

