



用户使用说明书

User's Instruction Manual

HUNTER

1/10 READY TO RUN
4X4 SC TRUCK



32km/hr
20+mph



Model # :8135

1/10 Scale 4WD Brushed Short Course Truck

Introduction

Thank you for choosing DHK's HUNTER! This short course truck(SCT) is designed in thorough research and assembled with utmost craftsmanship. Hunter is a 1:10 scale 4WD brushed SCT can run as fast as 22MPH/35KPH. It is easy to drive and it uses quality parts and accessories to achieve best performance. It will bring you a lot of joy and fun when you drive this model.

Before starting to run the model, you are kindly requested to take some time to review this instruction manual for a better operation. This easy to follow instruction manual aims to provide a general guideline for end-users. Kindly note that a good understanding of the model, its relevant parts together with other accessories packed in this consumer box will enable you to have fun in driving. Meanwhile, users are recommended to conduct regular maintenance for a smooth performance. Failure to do so might shorten the lifespan of your model. You are cordially advised that DHK Hobby makes all necessary parts and accessories to support you for any problem during and after your driving.

Before you operate this radio controlled model, you must understand the following:

1. Make sure that all screws and nuts are tightened securely.
2. Make sure that the batteries are fresh or fully charged so the vehicle won't lose control.
3. Do not drive the model in the following places/areas to avoid injury of people and damage to the public property. Drive your model in open areas.
 - > On public streets or parks. Cause injury or death of pedestrians, young children, animals and pets.
 - > On highways. Cause accidents or damage of the model.
 - > In water. Cause damage to electronic components and parts, or direct failure of the model.
4. Check all signals and electronic parts are working properly.

After running, battery, ESC, and motor can be very hot. Make sure not to touch with bare hands.



Warning:

This high performance model can run very fast. It is designed and produced for people of 14+ years of age to operate. Players under that age should be guided by adult supervision. Entry level players should seek guidance and supervision from experienced model players. Players are responsible for any/all accidental occurrences (human or animal injury, damage to property and possessions, breakage of the model itself) due to improper operation of this model.

Model specifications

Overall length	: 572mm (22.5 in)
Width	: 306mm (12.0 in) (Excluding body)
Height	: 153mm (6.02 in)(Excluding body)
Wheelbase	: 330mm (13 in)
Ground clearance	: 30mm (1.2 in)
Weight (net)	: 6.0lbs/2.70kgs(Excluding transmitter)
Front track/rear track	: 258mm/258mm (10.2 in/10.2 in)
Tire diameter/width	: Φ 108*45mm (Φ 4.3*1.8 in)
Wheel diameter/width	: Φ 60.5*40mm (Φ 2.4*1.6 in)
Gear ratio	: 10.97:1

Articles required to operate the model

4 pcs AA batteries (Ni-Mh or Ni-Cd rechargeable batteries, or non-rechargeable alkaline batteries) for 2.4GHz transmitter. Please refer to the 2.4GHz transmitter Instruction Manual.



2 Channel 2.4GHz radio system

HUNTER comes with a full function 2 channel 2.4GHz radio transmitter and receiver. Please refer to the 2.4GHz User's Instructions Manual for detail.

Hunter comes with 45A brushed electronic speed controller (**Version A**).

Version A (6-cell NiMh battery)

For this version, the battery that comes with Hunter is a 6-cell 7.2V SC type NiMh battery. The battery is with Tamiya style connector, so does the battery charger. Besides, the ESC also has a Tamiya connector to match it on the battery.

Below you may read the features and specifications of the ESC that's equipped on Hunter.

Instructions on ESC (Part# H111) V2.3

The brushed ESC is for brushed RC models. To maximize its function, you are kindly advised to read the following notes.

This ESC is compatible with Lipo battery, NiCd and NiMh battery. For Lipo battery, 2S cell only. The ESC complies with as high as 7.2V NiCd/NiMh battery. It works with low voltage from 4.8V.

Specifications

Input: 6V-8.4V

BEC: 2A/5.6V

Continuous current: 80A

Burst current: 320A (forward), 250A(brake), 160A(backward)

Peak current: 320A

Fail safe device: Yes

Low voltage protection: Yes

Over voltage protection: Yes
Compatible with 550 motor: 10T-23T (Preferably with 15T motor)
Dimension: 34*34*15.2mm

Operations

1>Plug in battery wire, Red pin is positive pole, Black pin is negative pole. Connecting to standard DC plug is also fine.

2>Switch on the power, there comes alarming sound if no signal is sent. The alarming sound stops when signal is sent out.

3>Switch on the transmitter. Move the trim to neutral point at which location red or green LED stops flashing. Push the throttle trigger, green LED is on, the model goes forward. Pull the trigger back after neutral point brings you to brake status. The more you pull the trigger backward, the greater the brake is being commended. Release the trigger to neutral point, and pull it back to brake the model. At this time, the red LED is on.

Warning

Avoid water. Avoid reverse connection.

Special features

The low voltage protection stops the unit when the average voltage reaches 5V, this greatly avoids battery damage. This also helps to reduce negative impact to nearby electronic devices. As compact a device as this ESC is, it provides powerful energy, but with as low resistance as 0.0013Ω. The emulated brake technology greatly improves the stableness, it also effectively reduces the sparks produced by the brush and motor turns to prolong the brush life span.

Hunter may come with a 7-cell NiMh battery (**Version B**) to improve its performance and speed.

Version B (7-cell NiMh battery)

For this version, the battery that comes with Hunter is a 7-cell 8.4V SC type NiMh battery. The battery is with T-connector, so does the battery charger. Besides, the ESC also has a T-connector to match it on the battery.

Below you may read the features and specifications of the high voltage ESC for your Hunter.

High Voltage ESC (Part# H126)

Features

1. Auto search throttle neutral point.
2. HF drive system
3. Over-heat protection (90C°)
4. Lipo battery low-voltage protection (2S Lipo-6.6V cutoff, 3S Lipo-9.9V shut down)
5. Low internal resistance & big capacity PCB board, providing great resistance to high current.
6. Forward, brake and reverse functions, good for both vehicles and boats.

Specifications

Forward current: 380A
Reverse current: 190A
Brake current: 250A
Voltage range: 4.8V-12.6V
PWM frequency: 1.5KHz
BEC voltage: 5V/2A

Operation

To obtain forward, brake and reverse functions and to switch battery types, kindly refer to the following

Skipping Needles Matrix for detail. This matrix provides clear information for operation.

Skipping Needles Matrix

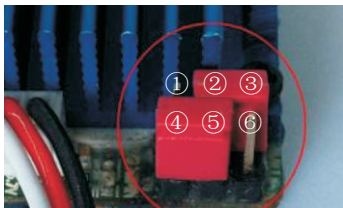

Needles placement and corresponding functions

Needles	Functions
1, 2	Forward, brake, reverse
2, 3	Forward, brake, no reverse
3, 4	Lipo battery
5, 6	NiMh battery

6kgs Servo

Features	: Plastic gears, ball bearings
Working voltage	: 4.8-6.0V
Speed (seconds/60°C)	: 0.18-0.16sec/60°
Torque	: 6kg/cm
Net weight	: 40g
Size(LxWxH)	: 40.8x20.1x38mm

NiMh Battery

This SCT comes with a single pack high rate NiMh stick-type battery. Handling NiMh batteries should be very careful. Please read the following points with regard to charging and discharging NiMh batteries.

Warning

- ▶ Never mix batteries from different manufacturers.
- ▶ Never mix batteries of different capacities.
- ▶ Never mix batteries of different chemistries, i.e. NiCd, NiMh, Lithium etc.
- ▶ Never DROP the battery if you can help it as NiMh batteries damage internally quite easily.
- ▶ Never store NiMh in the refrigerator.
- ▶ Never expose to extreme heat.
- ▶ Never make wrong polarity connection when charging and discharging battery packs. Always double check polarity of battery's connector to make sure red wire to red wire and black wire to black wire.
- ▶ Please always use a smart charger (with automatic power cut-off function) to charge NiMh battery. Charging NiMh battery without an attention may cause battery explosion.
- ▶ When charging NiMh battery, please always put the battery in a wire-proof place to avoid any accident.
- ▶ NiMh batteries have higher energy than NiCd battery, but they have higher self discharging rate and shorter shelf life. Therefore, please always keep NiMh cells / battery pack in charged condition after using or before storing them
- ▶ NiMh batteries and packs should be charged at least every six months, otherwise the capacity will reduce or it can become dead. For safety reasons, we usually ship NiMh battery without fully charged. NiMh battery must be charged before use, and allow 3-5 cycles of charging and discharging for battery capacity to recover.

Caution!

NiMh battery pack may be hot. Do not allow the battery's internal electrolyte to get in the eyes or on skin. Wash affected areas with soap and water immediately if they come in contact with the electrolyte. If electrolyte makes contact with the eyes, flush with large amounts of water for 15 minutes and seek medical attention immediately.

Environmental impact

Improper disposal of NiMh batteries poses less environmental hazard than that of NiCd because of the absence of toxic cadmium. However, mining and processing the various alternate metals that form the negative electrode may pose other types of environmental impact, depending on the metal, mining method, and environmental practices of the mine.

Terminology

Electronic speed controller (ESC)

An electronic circuit with the purpose to vary an electric motor's speed, its direction and possibly also to act as a dynamic brake. ESCs are often used on electrically-powered radio controlled models.

An ESC can be a stand-alone unit which plugs into the receiver's throttle control channel or incorporated into the receiver itself, as is the case in most toy-grade R/C vehicles. Some R/C manufacturers that install proprietary hobby-grade electronics in their entry-level vehicles, vessels or aircraft use onboard electronics that combine the two on a single circuit board.

Brush DC motors

A typical RC brushed motor looks like a small metal can with an axle sticking out of one end and battery leads on the other end. The commutator shaft, armature, wires, brushes, and magnets are contained inside that can. Those carbon brushes inside the can connect with the commutator shaft. When voltage is applied through the battery leads to the brushes in contact with the commutator shaft it causes the motor to spin and gives forward and reverse motion to the RC.

Brushed motors are rated by the number of turns of copper wire around the armature within the motor. Stock unmodified brushed motors are usually 20 turn motors but can go all the way down to 7 turn modified brush motors. A higher number of turns provides for more torque but also lower RPMs and less speed. But it also provides longer battery life. The lower the number of turns of the brushed motor, the more voltage can be applied with less torque and higher RPMs-resulting in more speed.

RC servos

Servos are hobbyist remote control devices typically employed in radio-controlled models, where they are used to provide actuation for various mechanical systems such as the steering of a car, the control surfaces on a plane, or the rudder of a boat.

Due to their affordability, reliability, and simplicity of control by microprocessors, RC servos are often used in small-scale robotics applications.

RC servos are composed of an electric motor mechanically linked to a potentiometer. A standard RC receiver sends Pulse-width modulation (PWM) signals to the servo. The electronics inside the servo translate the width of the pulse into a position. When the servo is commanded to rotate, the motor is powered until the potentiometer reaches the value corresponding to the commanded position.

RC servos use a three-pin 0.1" spacing jack (female) which mates to standard 0.025" square pins (which should be gold-plated, incidentally). The most common order is Signal, +voltage, ground. The standard voltage is 6VDC, however 4.8V and 12V has also been seen for a few servos. The control signal is a digital PWM signal with a 50Hz frame rate. Within each 20ms timeframe, an active-high digital pulse controls the position. The pulse nominally ranges from 1.0ms to 2.0ms with 1.5ms always being center of range. Pulse widths outside this range can be used for "overtravel" -moving the servo beyond its normal range. This PWM signal is sometimes (incorrectly) called Pulse Position Modulation (PPM).

The servo is controlled by three wires: ground, power, and control. The servo will move based on the pulses sent over the control wire, which set the angle of the actuator arm. The servo expects a pulse every 20 ms in order to gain correct information about the angle. The width of the servo pulse dictates the range of the servo's angular motion.

A servo pulse of 1.5 ms width will typically set the servo to its "neutral" position or 45°, a pulse of 1.25 ms could set it to 0° and a pulse of 1.75 ms to 90°. The physical limits and timings of the servo hardware varies between brands and models, but a general servo's angular motion will travel somewhere in the range of 90° - 120° and the neutral position is almost always at 1.5 ms. This is the "standard pulse servo mode" used by all hobby analog servos.

A hobby digital servo is controlled by the same "standard pulse servo mode" pulses as an analog servo. Some hobby digital servos can be set to another mode that allows a robot controller to read back the actual position of the servo shaft. Some hobby digital servos can optionally be set to another mode and "programmed", so it has the desired PID controller characteristics when it is later driven by a standard RC receiver.

RC servos are usually powered by the receiver which in turn is powered by battery packs or an Electronic speed controller (ESC) with an integrated or a separate Battery eliminator circuit (BEC) Common battery packs are either NiCd, NiMH or Lithium-ion polymer battery (LiPo) type. Voltage ratings vary, but most receivers are operated at 5V or 6V.

Parts List

Number	Desc
8381-102	Diff outdrive/pins (dia 2*10mm)
8381-103	Pins(dia 2*10mm) (16 pcs)
8381-104	Flathead screw-coarse thread(KB2.6*10mm) (16 pcs)
8381-106	Diff case set/diff case cover/diff gasket
8381-107	Washer-A/washer-B (8 pcs each)
8381-108	Gear-18T (2 pcs)/gear-12T (4 pcs)
8381-109	O Ring(dia 8mm * dia 2mm) (16 pcs)
8381-110	Ball bearing(dia 10mm * dia 15*4mm) (2 pcs)
8381-111	Diff pins(dia 4*25.8mm) (4 pcs)
8381-113	Flathead screw(KM2.6X6mm) (16 pcs)
8381-114	Ball bearing(dia 8mm * dia 14*4mm) (2 pcs)
8381-115	Pins(dia 2*8mm) (16 pcs)
8381-116	Pinion gear outdrive/pins(dia 2*8mm)
8381-117	Ball bearing(dia 5 mm * dia 11*4mm) (2 pcs)
8381-118	Diff gear box-F/R
8381-119	B head screw-coarse thread(BB3*16mm) (16 pcs)
8381-206	Center diff gear box/center diff gear box plate
8381-207	B head screw-coarse thread (BB3*20mm) (16 pcs)
8381-208	Center outdrive set
8381-305	Shock ball (8 pcs)
8381-306	M3 nylon nut (8 pcs)
8381-309	Shock shaft (4 pcs)
8131-301	Shock spring (4 pcs)
8381-50L	Assembly of upper sus.arm-Left
8381-50R	Assembly of upper sus.arm-right
8381-501	Upper sus.arm ball (4 pcs)
8381-502	Upper sus.arm/rod end (2 sets)
8381-503	Upper sus.arm linkage (2 pcs)
8381-601	Brass washer (4 pcs)
8381-602	Servo saver bushing/adjustment ring
8381-603	Servo saver spring (4 pcs)
8381-604	Servo saver sus. Arm-upper/lower/steering sus. Arm
8381-605	B head screw-coarse thread(BB3*12mm) (16 pcs)
8381-606	Screw bushing (16 pcs)
8381-608	Shaft (2 pcs)
8131-620	Assembly of steering linkage (2 pcs)
8381-621	Steering linkage (2 pcs)
8381-622	Plastic rod end (8 pcs)
8381-623	Double way ball end (8 pcs)
8381-701	Upper sus.arm mount-rear/suspension mount
8381-702	B head screw-coarse thread(BB3*14mm) (16 pcs)
8381-703	B head screw-coarse thread(BB3*10mm) (16 pcs)
8381-706	Lower sus.arm-front (2 pcs)
8381-707	Drive shaft set/revolving shaft (2 sets)

Number	Desc
8381-721	Lower sus.arm plate-front
8381-723	C-hub screw bushings (16 pcs)
8381-724	T head hex screws (TM4*12mm) (16 pcs)
8381-725	T head hex screws (TM4*22mm) (16 pcs)
8381-726	B head screw-coarse thread(BB3*18mm) (16 pcs)
8381-727	B head screw(BM3*56mm) (8 pcs)
8381-728	B head screw(BM3*43mm) (8 pcs)
8382-703	Body post holder/body post
8382-705	B head screw(BM3*24mm) (16 pcs)
8381-801	Lower sus.arm-rear (2 pcs)
8381-802	Rear hub-L/R
8381-803	B head screw(BM3*18mm) (16 pcs)
8381-805	B head screw(BM3*10mm) (16 pcs)
8381-807	Pin-A(dia 1.5mm) (16 pcs)
8131-9M2	Motor gear-18T/Lock nut(M3*3)
8381-9S1	Servo mount
9381-9B4	Servo arm-B (2 pcs)
8131-9S2	B head screw(BM2.6*6mm) (12 pcs)
8381-9Z0	Assembly of steering tie rod
8381-9Z1	Steering tie rod (2 pcs)
8381-005	Central drive shaft-A
8381-006	Central drive shaft-B
8381-008	Antenna tube (3 pcs)
8381-009	Pin-B(Φ1.2mm) (16 pcs)
8381-010	Screw washer(4 pcs)
8381-011	Flathead screw(KM3X10mm) (16 pcs)
8381-012	Flathead screw-coarse thread (KB3*10mm) (16 pcs)
8381-016	Upper deck-A
8381-017	Upper deck-B
8381-024	Flathead screw(KM4X11.5mm) (12 pcs)
8133-100	Assembly of diff gear box
8133-101	Diff set
8133-102	Crown gear-41T (large)/pinion gear-11T (small)
8133-103	Assembly of the pinion gear
8135-001	Tire complete (black rims) (2 pcs)
8135-002	Chassis
8135-003	Body nerf bars (left & right)
8135-004	Upper deck mount-F/R
8135-005	Battery mount-C/D
8381-007	Receiver cover-upper/lower
8135-007	Tires with foams (unglued) (2 pcs)
8135-008	Wheels (2 pcs)
8135-009	Printed SCT body (PC) (W/body decals)
8135-009C	Clear SCT body (PC) (W/body decals and window cutout)
8135-010	Body decals (Hunter)
8135-200	Central diff gear box(complete)
8135-201	Central diff set
8135-202	Differential lock
8135-203	Spur gear-53T(plastic) (2 pcs)
8135-301	Shock absorber complete (2 pcs)
8135-600	Servo saver assembly-complete
8135-601	Steering plate

Parts List

Number	Desc
8381-710	Ball bearing(dia 6mm * dia 12*4mm) (2 pcs)
8381-714	C-hub (2 pcs)
8381-717	Shock tower (2 pcs)
8381-718	Pivot ball mount (4 pcs)
8381-719	Upper sus.arm shaft (4 pcs)
8135-9M1	Motor mount
8133-002	7.2V NiMh battery charger 8.5V 500mAh output, 100-240V input (Version A)
D303	Servo (6kg)
D302T	2.4GHz Transmitter
D302S	2.4GHz receiver

Number	Desc
8135-701	Wheel axle (2 pcs)
8135-702	Steering arm (2 pcs)
8135-703	Hex adapter (4 pcs)
8135-704	Set screws-M4 (4 pcs)
8135-705	Front bumper/upper sus.arm mount-front
8135-801	Rear bumper/upper sus.arm mount-front
H111	Brushed ESC 45A (Version A)
H112	Brushed motor 550
H113	7.2V SC 1800mAh NiMh battery (Version A)
H125	8.4V/SC/1800mAh battery T connector (Version B)
H126	High voltage ESC (Version B)
H131	7-cell 8.4V NiMh battery charger-T connector (Version B)

Optional Parts

8381-400	Anti-roll bar assembly
8381-40L	Assembly of anti-roll bar linkage-Left
8381-40R	Assembly of anti-roll bar linkage-Right
8381-401	Anti-roll bar rod end (8 pcs)
8381-402	Anti-roll bar linkage (4 pcs)
8381-403	Anti-roll bar pivot ball-upper/lower (4 sets)
8381-404	Set screws (M3*3mm) (8 pcs)
8381-405	Anti-roll bar(dia 2.2mm) (2 pcs)
8381-607	Steering plate
8381-709	Steering arm (2 pcs)
8381-716	Set screws (M4*10mm) (16 pcs)
D302HT	2.4GHz LCD transmitter

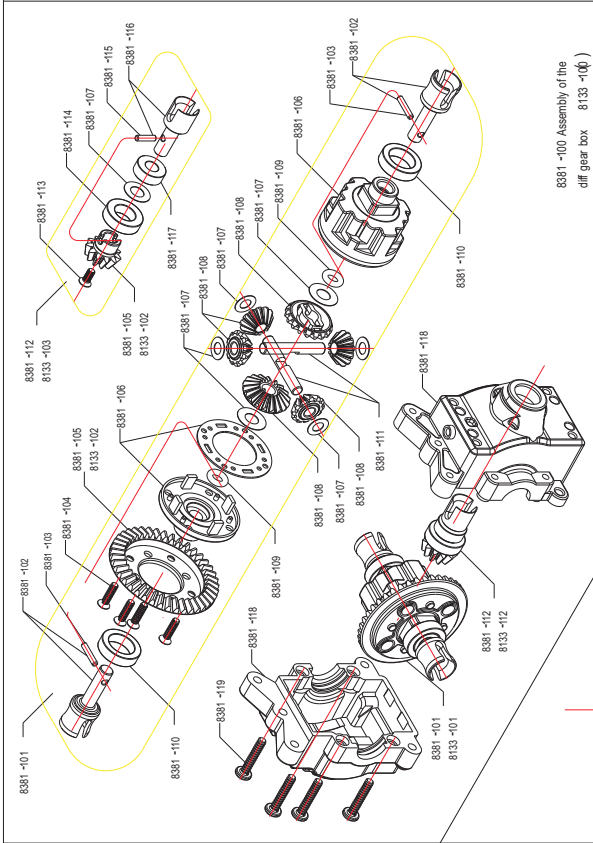

8381-100 Assembly of the
diff gear box 8133-100

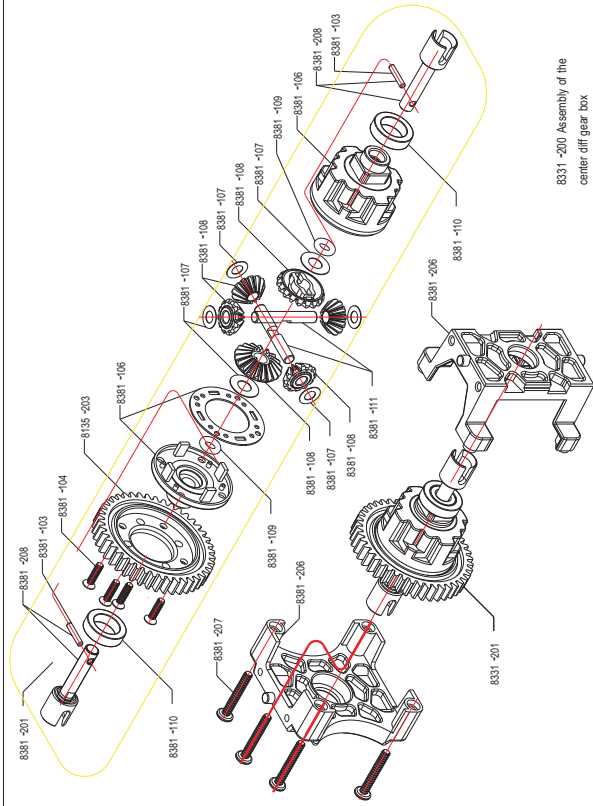

8331-200 Assembly of the
center diff gear box

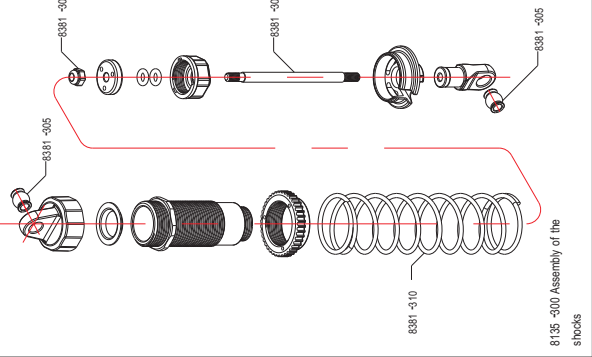

8135-500 Assembly of the
shocks

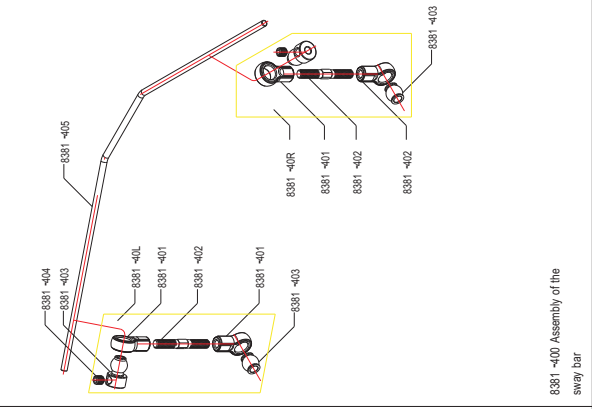

8381-400 Assembly of the
sway bar

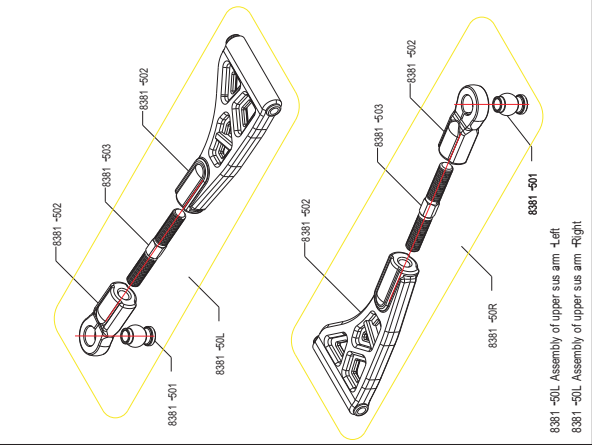

8381-501 Assembly of upper sus arm -Left
8381-501L Assembly of upper sus arm -Right
8381-501R

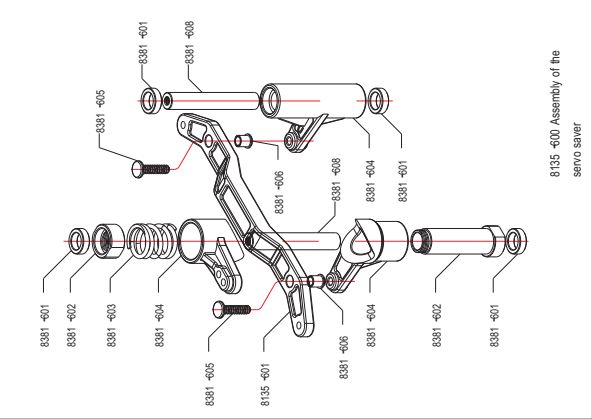

8135-600 Assembly of the
servo saver

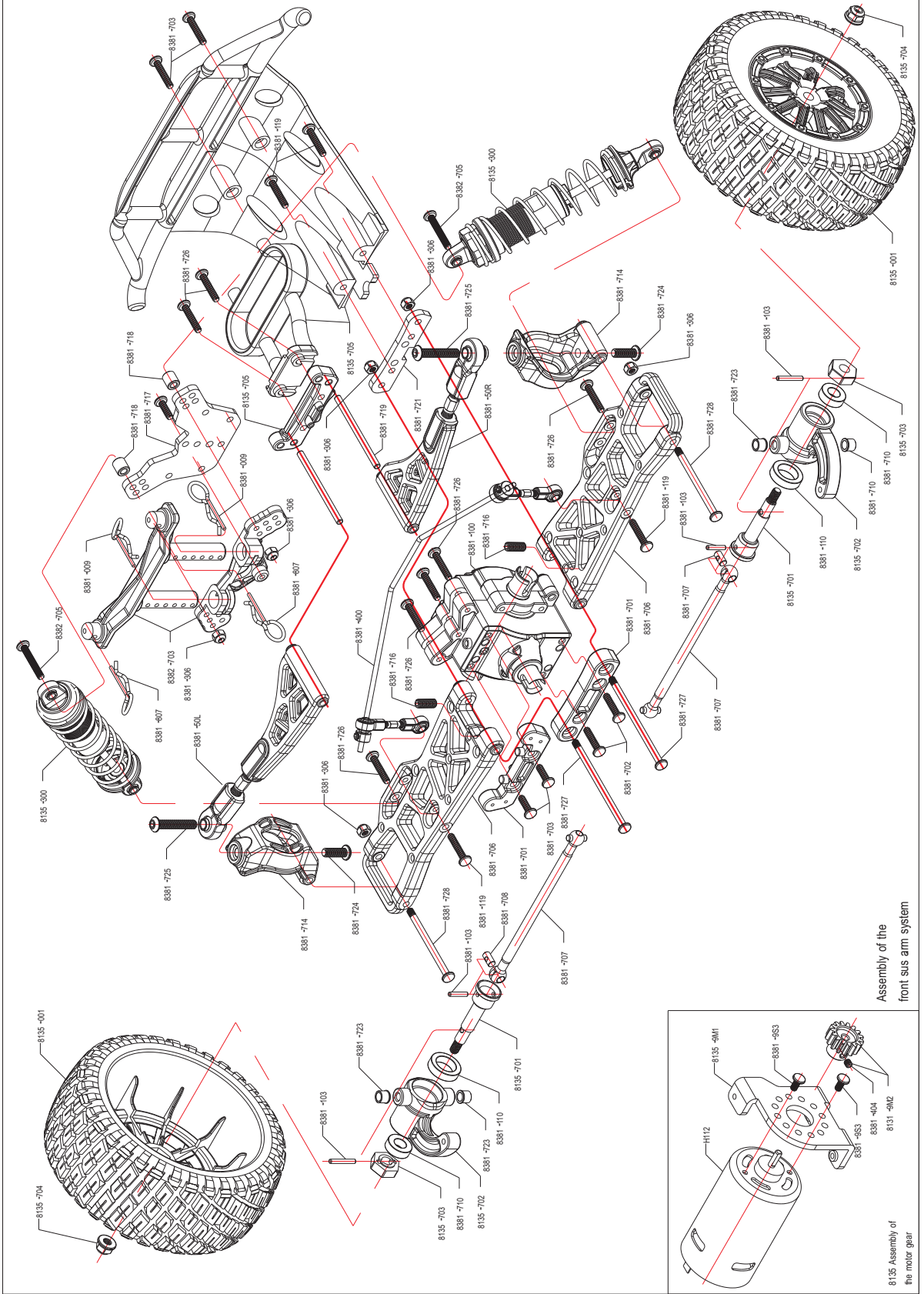

Assembly of the front sus arm system

8135 Assembly of the motor gear

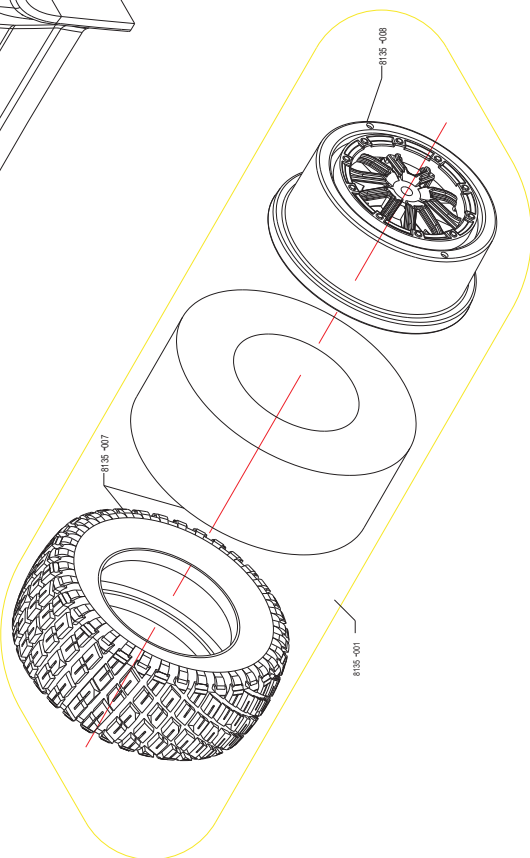
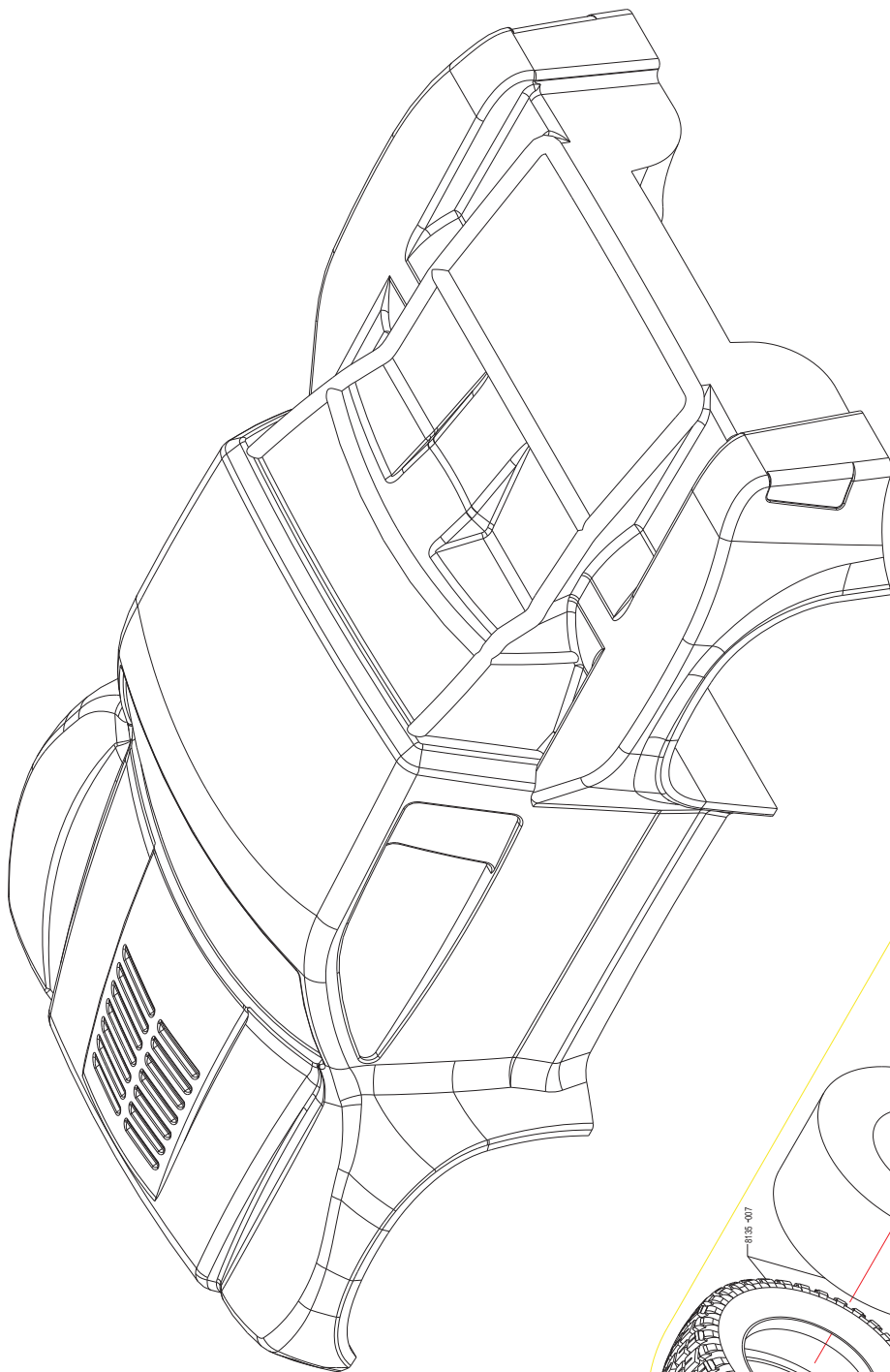

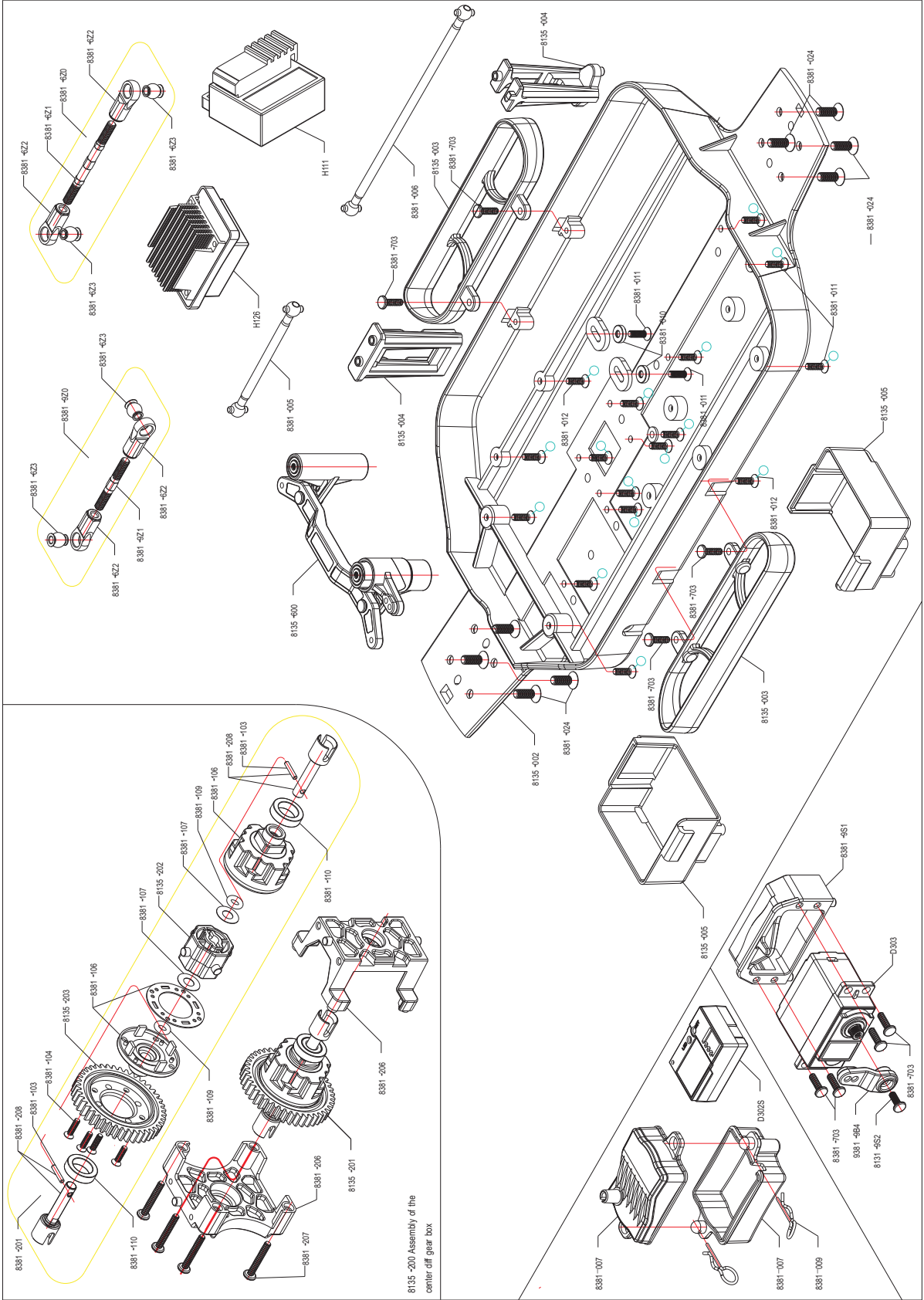

8135-200 Assembly of the center diff gear box

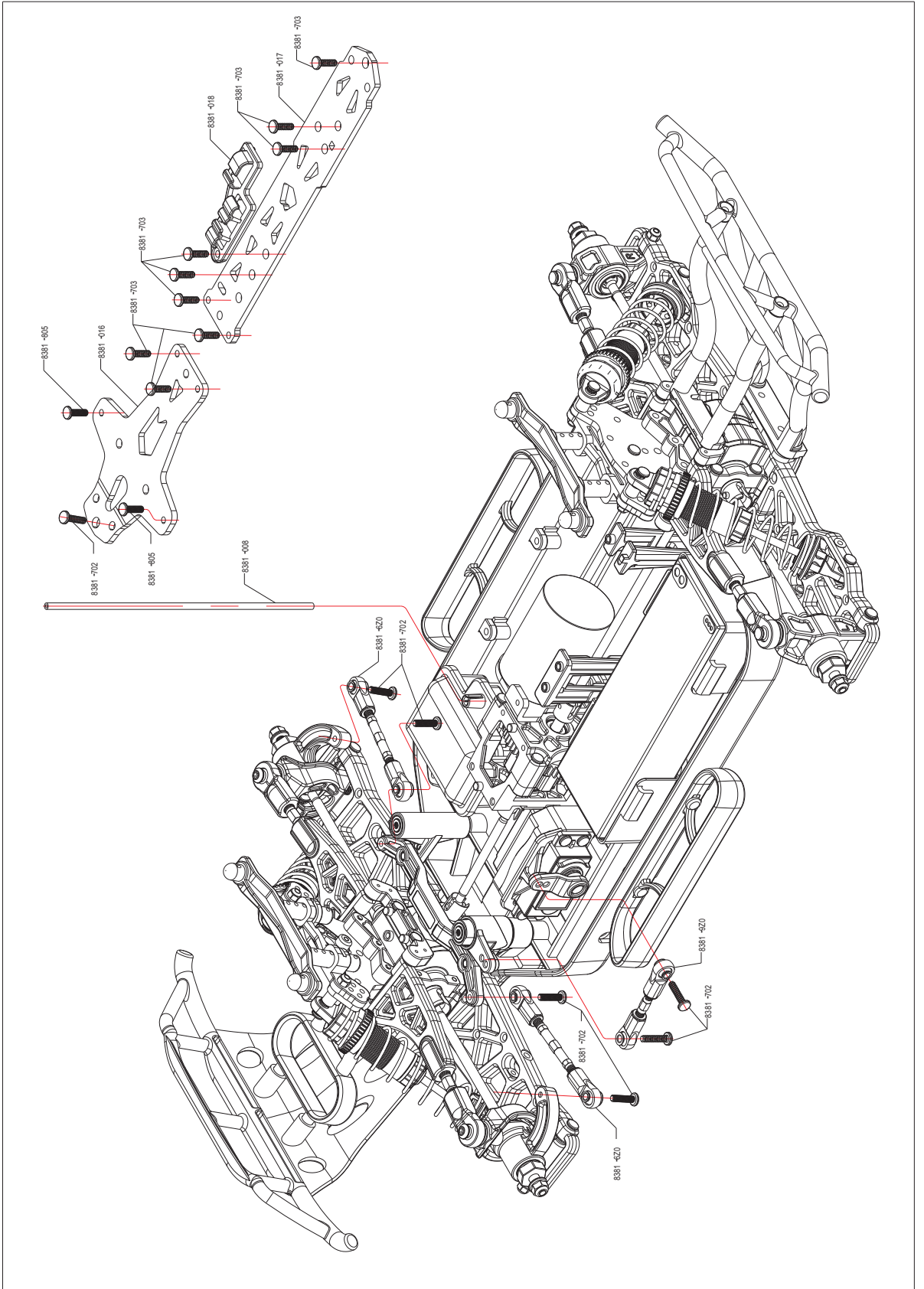

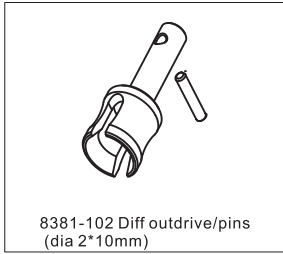

8381-102 Diff outdrive/pins
(dia 2*10mm)

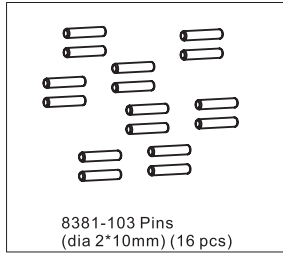

8381-103 Pins
(dia 2*10mm) (16 pcs)

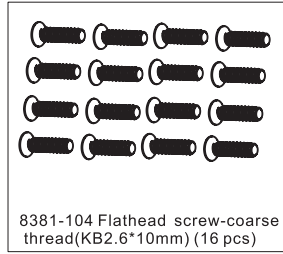

8381-104 Flathead screw-coarse
thread(KB2.6*10mm) (16 pcs)

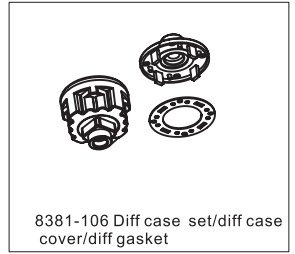

8381-106 Diff case set/diff case
cover/diff gasket

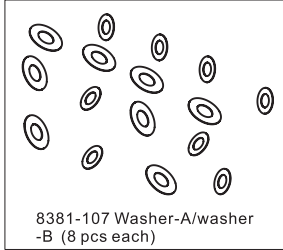

8381-107 Washer-A/washer
-B (8 pcs each)



8381-108 Gear-18T (2 pcs)/
gear-12T (4 pcs)

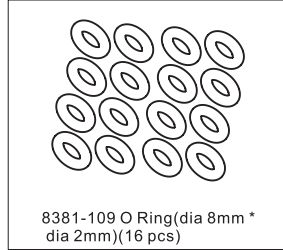

8381-109 O Ring(dia 8mm *
dia 2mm)(16 pcs)

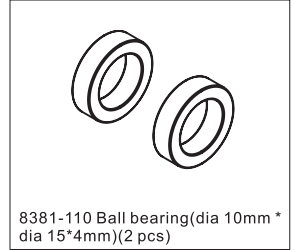

8381-110 Ball bearing(dia 10mm *
dia 15*4mm)(2 pcs)

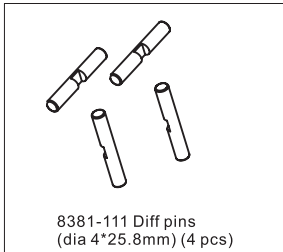

8381-111 Diff pins
(dia 4*25.8mm) (4 pcs)

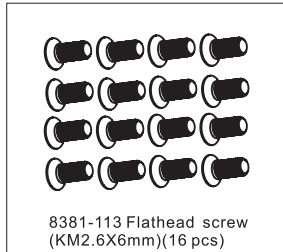

8381-113 Flathead screw
(KM2.6X6mm)(16 pcs)

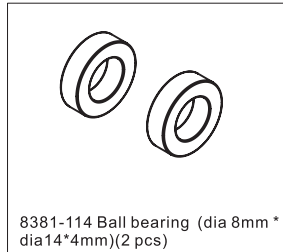

8381-114 Ball bearing (dia 8mm *
dia 14*4mm)(2 pcs)

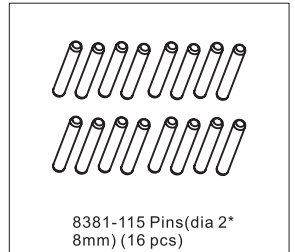

8381-115 Pins(dia 2*
8mm) (16 pcs)

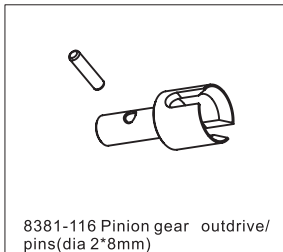

8381-116 Pinion gear outdrive/
pins(dia 2*8mm)

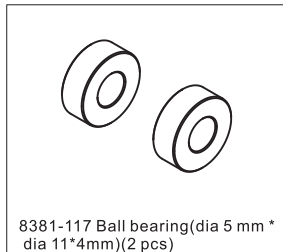

8381-117 Ball bearing(dia 5 mm *
dia 11*4mm)(2 pcs)

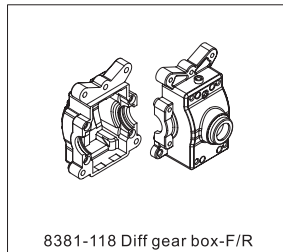

8381-118 Diff gear box-F/R

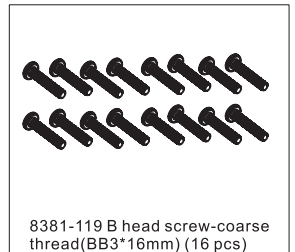

8381-119 B head screw-coarse
thread(BB3*16mm) (16 pcs)

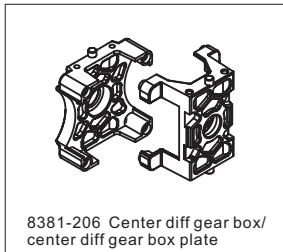

8381-206 Center diff gear box/
center diff gear box plate



8381-207 B head screw-coarse
thread(BB3*20mm) (16 pcs)

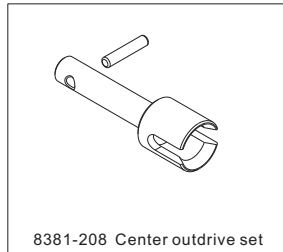

8381-208 Center outdrive set



8381-305 Shock ball (8 pcs)

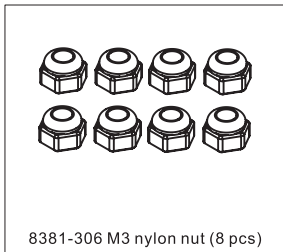

8381-306 M3 nylon nut (8 pcs)



8381-309 Shock shaft (4 pcs)



8131-301 Shock spring (4pcs)



8381-50L Assembly
of upper sus.arm-Left

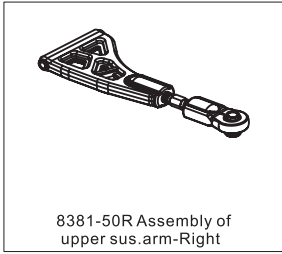

8381-50R Assembly of upper sus.arm-Right

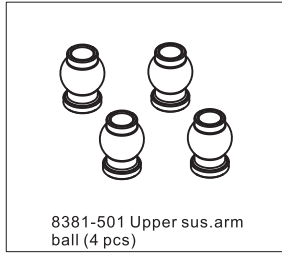

8381-501 Upper sus.arm ball (4 pcs)

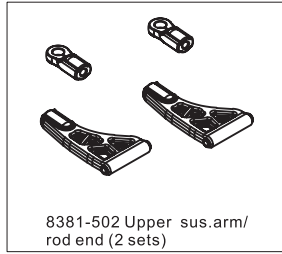

8381-502 Upper sus.arm/rod end (2 sets)

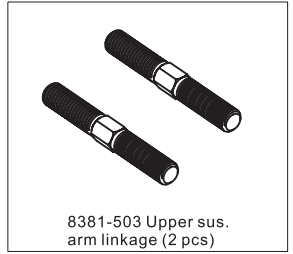

8381-503 Upper sus.arm linkage (2 pcs)

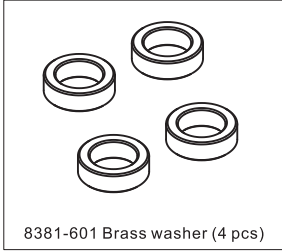

8381-601 Brass washer (4 pcs)



8381-602 Servo saver bushing/adjustment ring

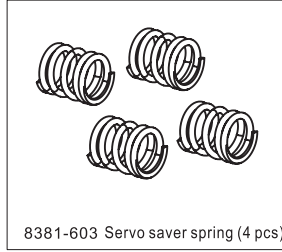

8381-603 Servo saver spring (4 pcs)

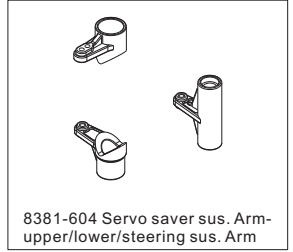

8381-604 Servo saver sus. Arm-upper/lower/steering sus. Arm

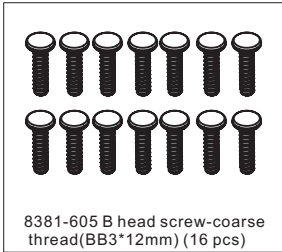

8381-605 B head screw-coarse thread(BB3*12mm) (16 pcs)

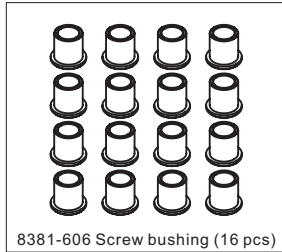

8381-606 Screw bushing (16 pcs)

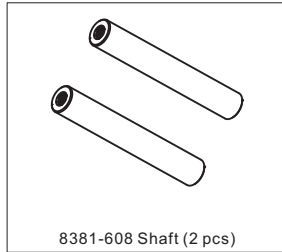

8381-608 Shaft (2 pcs)

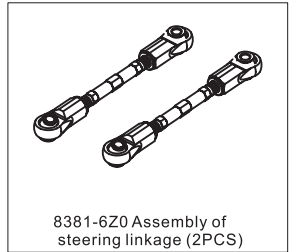

8381-6Z0 Assembly of steering linkage (2PCS)

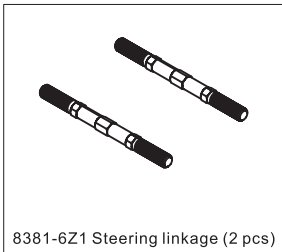

8381-6Z1 Steering linkage (2 pcs)

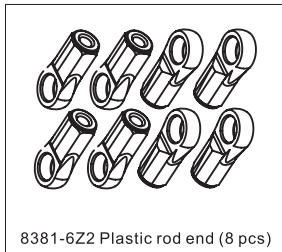

8381-6Z2 Plastic rod end (8 pcs)

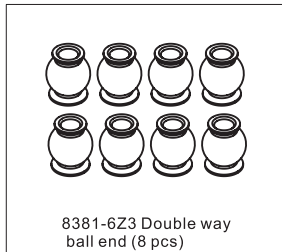

8381-6Z3 Double way ball end (8 pcs)

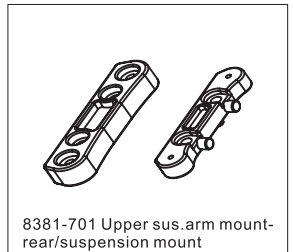

8381-701 Upper sus.arm mount-rear/suspension mount

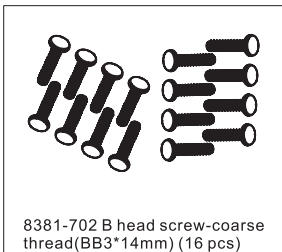

8381-702 B head screw-coarse thread(BB3*14mm) (16 pcs)

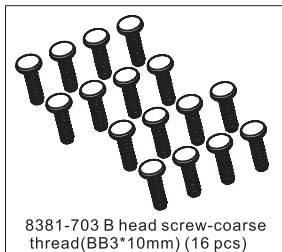

8381-703 B head screw-coarse thread(BB3*10mm) (16 pcs)

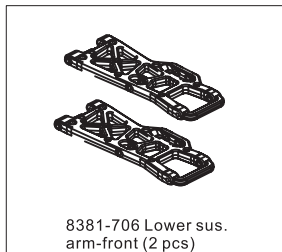

8381-706 Lower sus.arm-front (2 pcs)

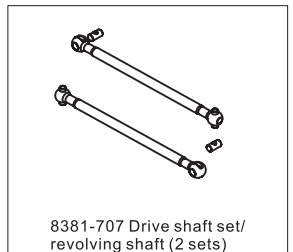

8381-707 Drive shaft set/revolving shaft (2 sets)



8381-710 Ball bearing(dia 6mm* dia 12*4mm) (2 pcs)

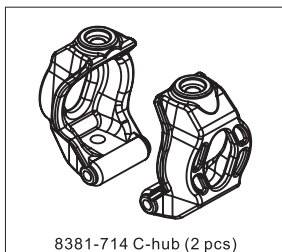

8381-714 C-hub (2 pcs)

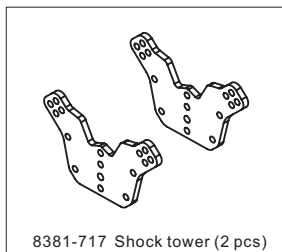

8381-717 Shock tower (2 pcs)

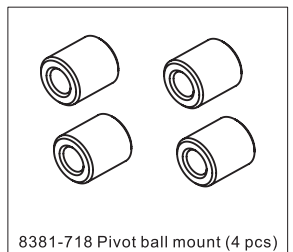

8381-718 Pivot ball mount (4 pcs)

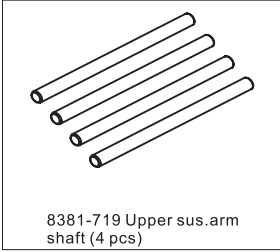

8381-719 Upper sus.arm shaft (4 pcs)

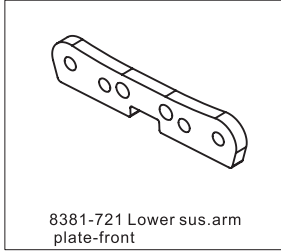

8381-721 Lower sus.arm plate-front

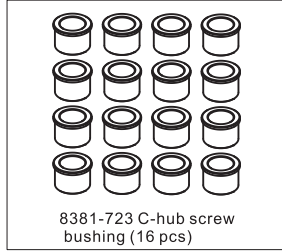

8381-723 C-hub screw bushing (16 pcs)

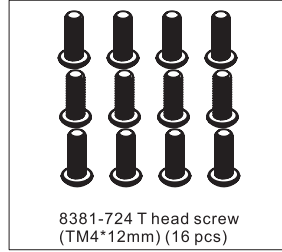

8381-724 T head screw (TM4*12mm) (16 pcs)

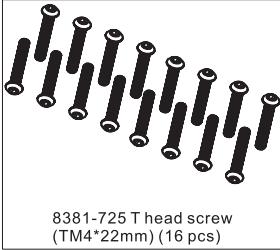

8381-725 T head screw (TM4*22mm) (16 pcs)

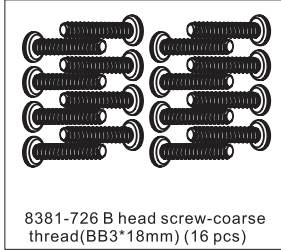

8381-726 B head screw-coarse thread(BB3*18mm) (16 pcs)

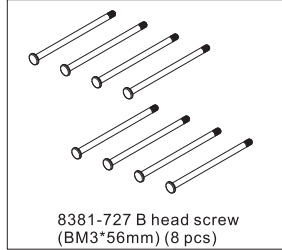

8381-727 B head screw (BM3*56mm) (8 pcs)

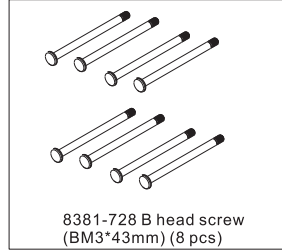

8381-728 B head screw (BM3*43mm) (8 pcs)

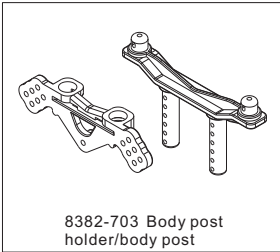

8382-703 Body post holder/body post

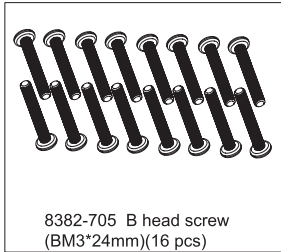

8382-705 B head screw (BM3*24mm)(16 pcs)

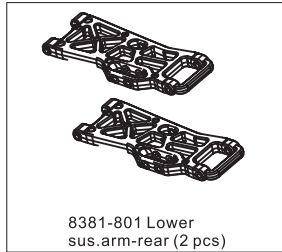

8381-801 Lower sus.arm-rear (2 pcs)

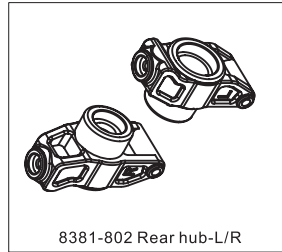

8381-802 Rear hub-L/R

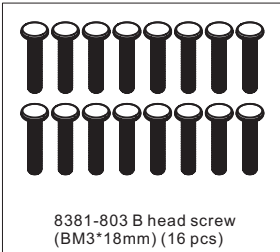

8381-803 B head screw (BM3*18mm) (16 pcs)

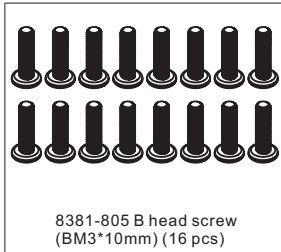

8381-805 B head screw (BM3*10mm) (16 pcs)

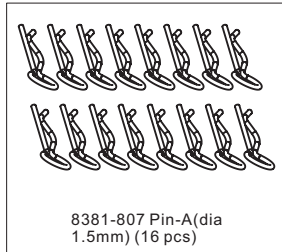

8381-807 Pin-A(dia 1.5mm) (16 pcs)

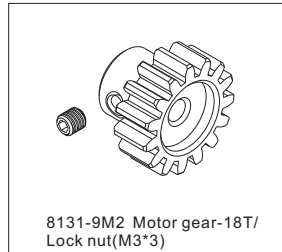

8131-9M2 Motor gear-18T/ Lock nut(M3*3)

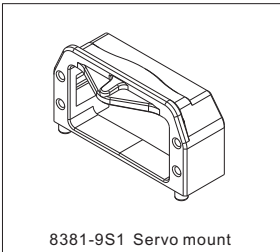

8381-9S1 Servo mount

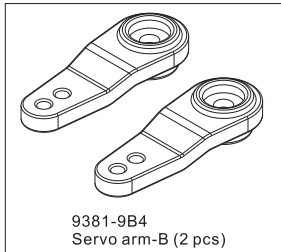

9381-9B4 Servo arm-B (2 pcs)

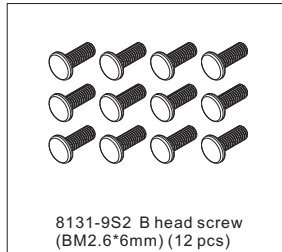

8131-9S2 B head screw (BM2.6*6mm) (12 pcs)

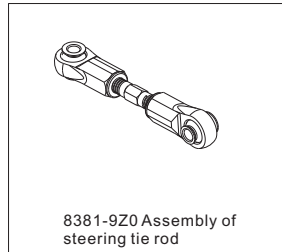

8381-9Z0 Assembly of steering tie rod

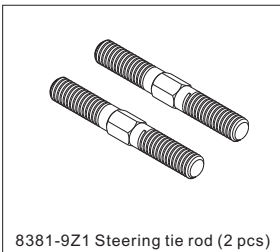

8381-9Z1 Steering tie rod (2 pcs)

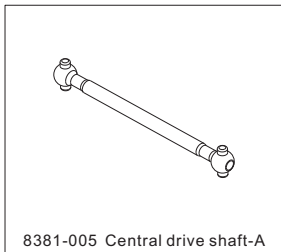

8381-005 Central drive shaft-A

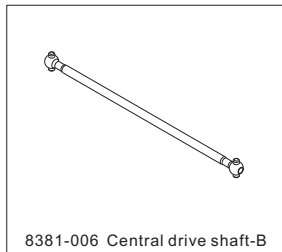

8381-006 Central drive shaft-B

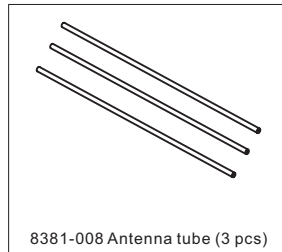

8381-008 Antenna tube (3 pcs)

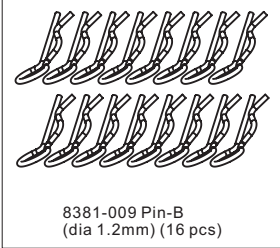

8381-009 Pin-B
(dia 1.2mm) (16 pcs)



8381-010 Screw washer

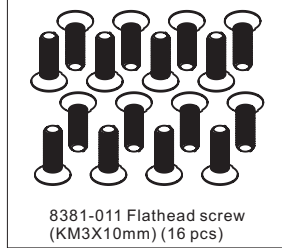

8381-011 Flathead screw
(KM3X10mm) (16 pcs)

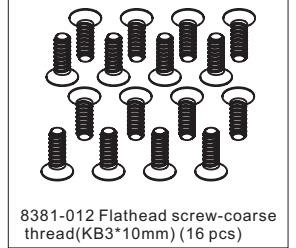

8381-012 Flathead screw-coarse
thread(KB3*10mm) (16 pcs)

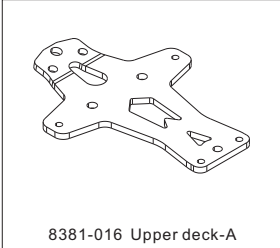

8381-016 Upper deck-A

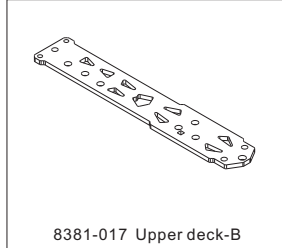

8381-017 Upper deck-B

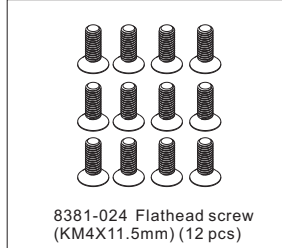

8381-024 Flathead screw
(KM4X11.5mm) (12 pcs)

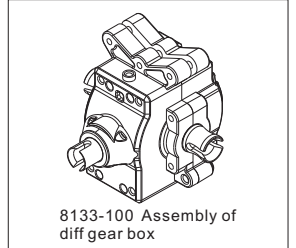

8133-100 Assembly of
diff gear box

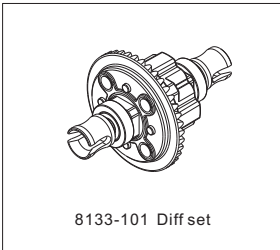

8133-101 Diff set

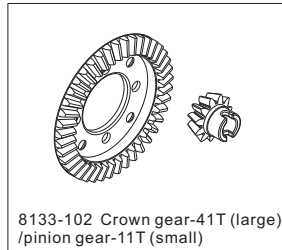

8133-102 Crown gear-41T (large)
/pinion gear-11T (small)

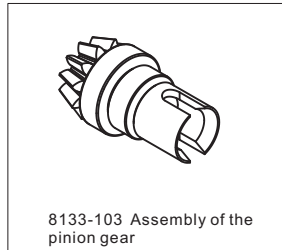

8133-103 Assembly of the
pinion gear

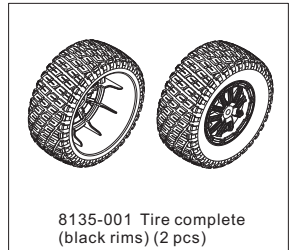

8135-001 Tire complete
(black rims) (2 pcs)

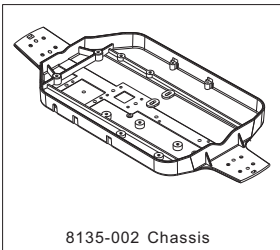

8135-002 Chassis

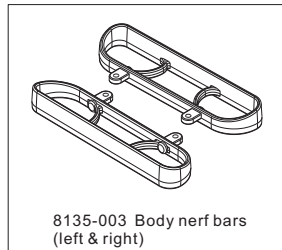

8135-003 Body nerf bars
(left & right)

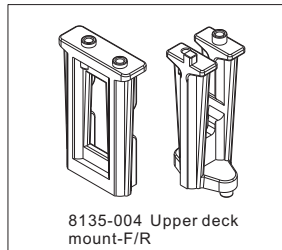

8135-004 Upper deck
mount-F/R

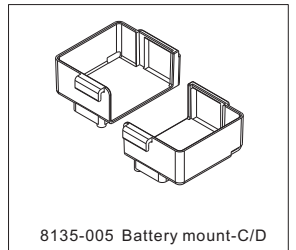

8135-005 Battery mount-C/D

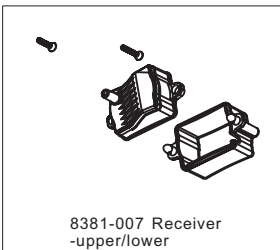

8381-007 Receiver
-upper/lower



8135-007 Tires with foams
(unglued) (2 pcs)



8135-008 Wheels (2 pcs)

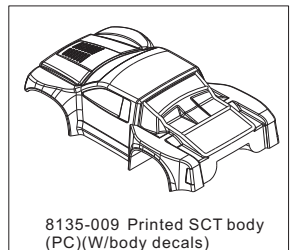

8135-009 Printed SCT body
(PC)(W/body decals)

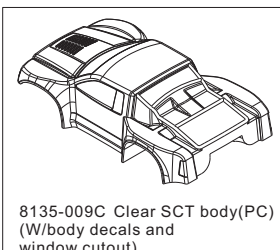

8135-009C Clear SCT body(PC)
(W/body decals and
window cutout)



8135-010 Body decals (Hunter)

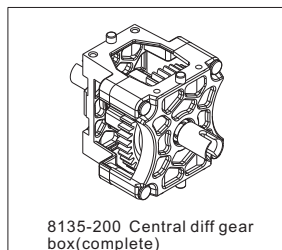

8135-200 Central diff gear
box(complete)

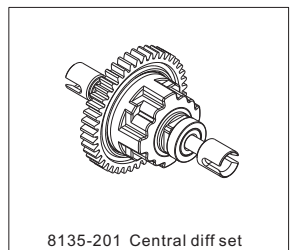

8135-201 Central diff set

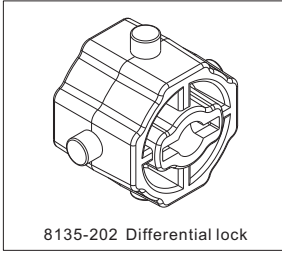

8135-202 Differential lock

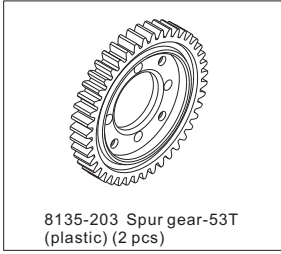

8135-203 Spur gear-53T (plastic) (2 pcs)

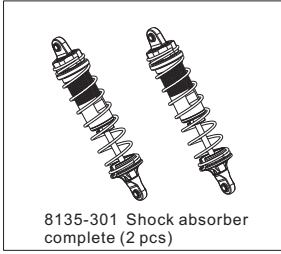

8135-301 Shock absorber complete (2 pcs)

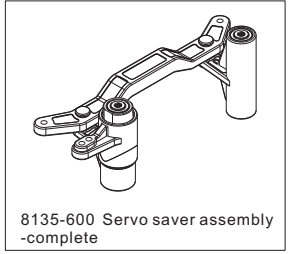

8135-600 Servo saver assembly -complete

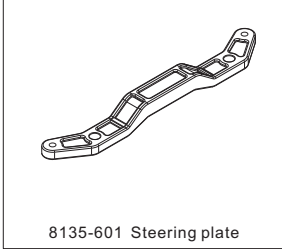

8135-601 Steering plate

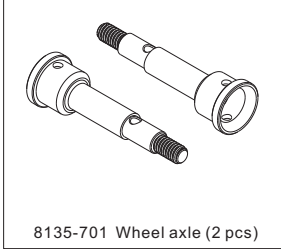

8135-701 Wheel axle (2 pcs)

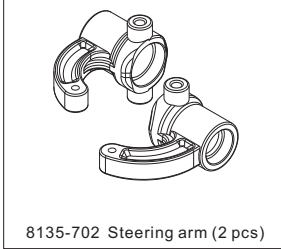

8135-702 Steering arm (2 pcs)

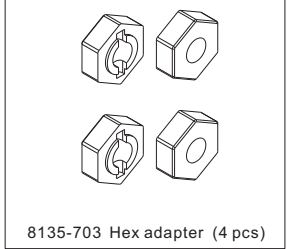

8135-703 Hex adapter (4 pcs)

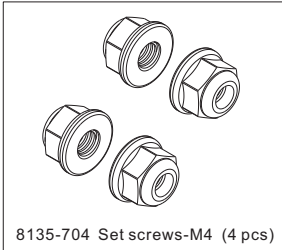

8135-704 Set screws-M4 (4 pcs)

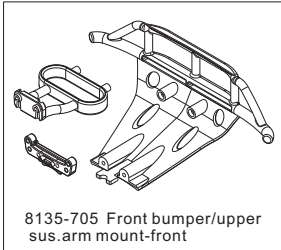

8135-705 Front bumper/upper sus.arm mount-front

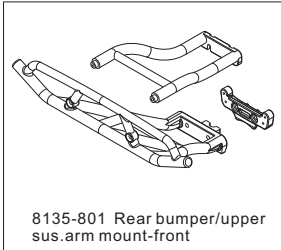

8135-801 Rear bumper/upper sus.arm mount-front

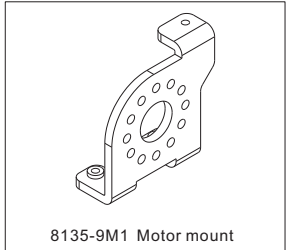

8135-9M1 Motor mount

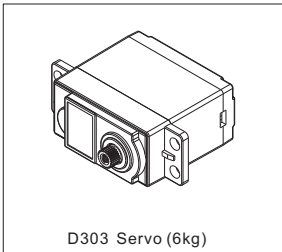

D303 Servo (6kg)



D302T 2.4GHz transmitter



D302S 2.4GHz receiver

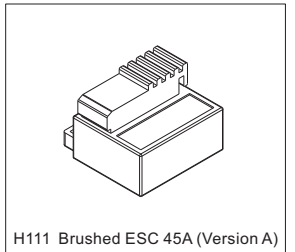

H111 Brushed ESC 45A (Version A)

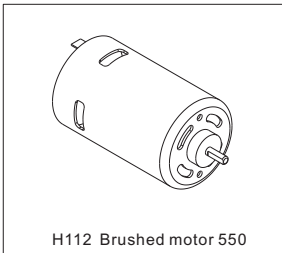

H112 Brushed motor 550



H113 7.2V SC 1800mAh NiMh battery (Version A)



H125 8.4V/SC/1800mAh battery T connector (Version B)

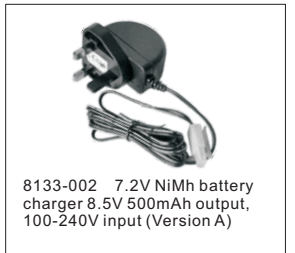

8133-002 7.2V NiMh battery charger 8.5V 500mAh output, 100-240V input (Version A)

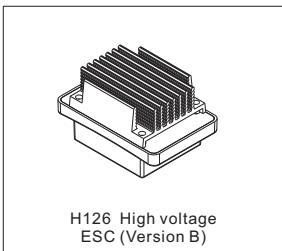

H126 High voltage ESC (Version B)



H131 7-cell 8.4V NiMh battery charger-T connector (Version B)

Optional Parts

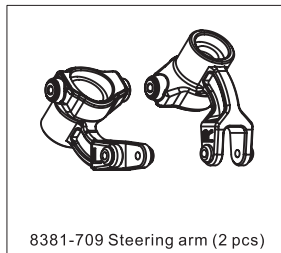
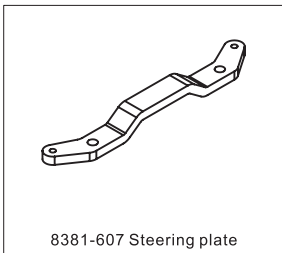
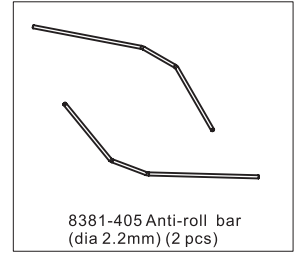
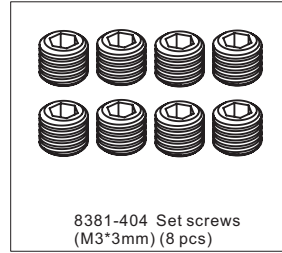
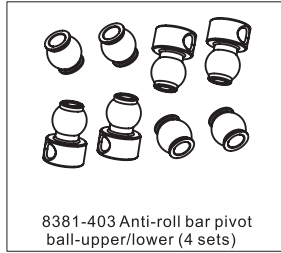
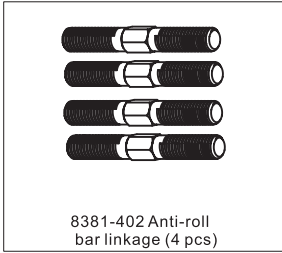
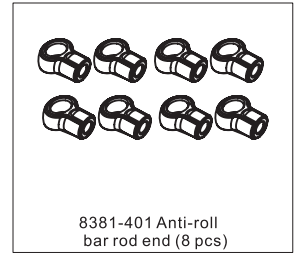
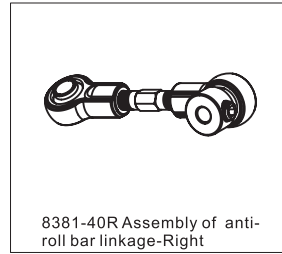
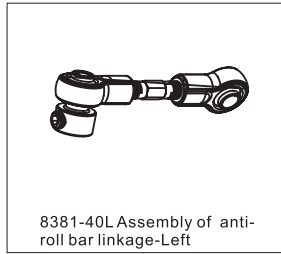
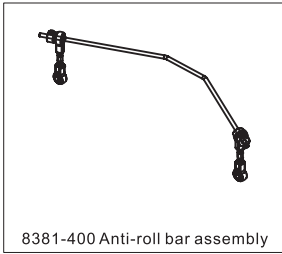

Annex: 2.4GHz Transmitter Manual

PART I:

2.4GHz Transmitter (Standard, Model#: D302T)

Safety Precautions

1. The 2.4GHz transmitter and receiver are pre-bound at the factory.
2. Please always use the same receiver model from the factory to match your 2.4GHz transmitter when you need to replace it. Receivers from other suppliers don't work on DHK HOBBY 2.4GHz transmitter.
3. When you need to replace a receiver, please make sure that it is bound with the transmitter before use.
4. Please operate the transmitter in vast areas where no radio interference exists. It's strongly recommended that no humans, animals or high voltage grid should be nearby.
5. Please do not operate this transmitter during fatigue, sickness, intoxication or in bad mood.
6. Do not operate the transmitter at night time, in the rain and thunderstorm or at low visibility.
7. Always use the same types of batteries in the transmitter. Do not mix old and new batteries in the transmitter. Please check the battery power before use. Replace batteries whenever the power is low to avoid out of control.
8. Before you operate the transmitter, please check the switch, batteries, servo and ESC for proper connection.
9. ALWAYS switch on the transmitter first, and off last so as to avoid possible radio interference from other sources. Failure to do so may cause out of control of your vehicle.
10. Before operation, check the servo forward and reverse functions, motor range, and neutral position. Modify it when necessary.
11. Please handle the transmitter with care. Store the transmitter in a dry and clean place when it's not in use for some time.

Transmitter Specifications

Channels	2 channels
Model types	Cars, boats
Frequency range	2.40-2.483GHz
RF power	≤20dB
Power output	10mW
Bandwidth	1M
Band number	64
2.4GHz modulation	AFHDS
Encoding	GFSK

Channel resolution	4096
Remote range	>200M
TH range	0.9mS-2.1mS
ST range	0.9mS-2.1mS
Battery voltage	6V (1.5V*4 cells)
Low voltage protection	≤4.4V
Weight	320g
USB port	N/A
Charging port	Yes

2.4GHz Standard Transmitter Parts and Functions

- 1-Antenna: pull up the antenna straight before use.
- 2-Power switch: slide the switch to turn on or off.
- 3-Power LED: shows the power strength. Green LED shows full power, Yellow LED flashes when the power is running short.
- 4-Charging port: charges Ni-Mh or Ni-Cd batteries only. Alkaline batteries are not rechargeable. NEVER charge your alkaline batteries.
- 5-Throttle trigger: Please refer to the transmitter diagram.
- 6-Steering wheel: Please refer to the transmitter diagram.
- 7-ST-D/R trim: adjust the steering servo angle ranging from 0% to 120%.
- 8-TH-D/R trim: adjust the throttle servo angle ranging from 0% to 120%.
- 9-ST-TRIM: adjust the steering neutral position, from 0% to 20%.
- 10-TH-TRIM: adjust the throttle neutral position, from 0% to 20%.
- 11-ST-NOR/REV: slide to left or right to choose steering mode.

12-TH-NOR/REV: push the trigger or pull it back to choose the throttle mode.

13-Throttle trigger trim screws: use a hex driver to tighten or loosen the screw to a comfortable level.

14-Battery compartment cover: to open the compartment, slide the cover to OPEN direction as indicated, snap it to close the compartment.

15-Battery case: open the battery cover, install 4 pcs AA 1.5V alkaline or rechargeable batteries based on the "+" & "-" poles. If the status LED flashes red, the transmitter batteries may be weak, discharged or possibly installed incorrectly. Replace with new or freshly charged batteries. The power indicator light does not indicate the charge level of the battery pack installed in the model.

Parts Diagrams

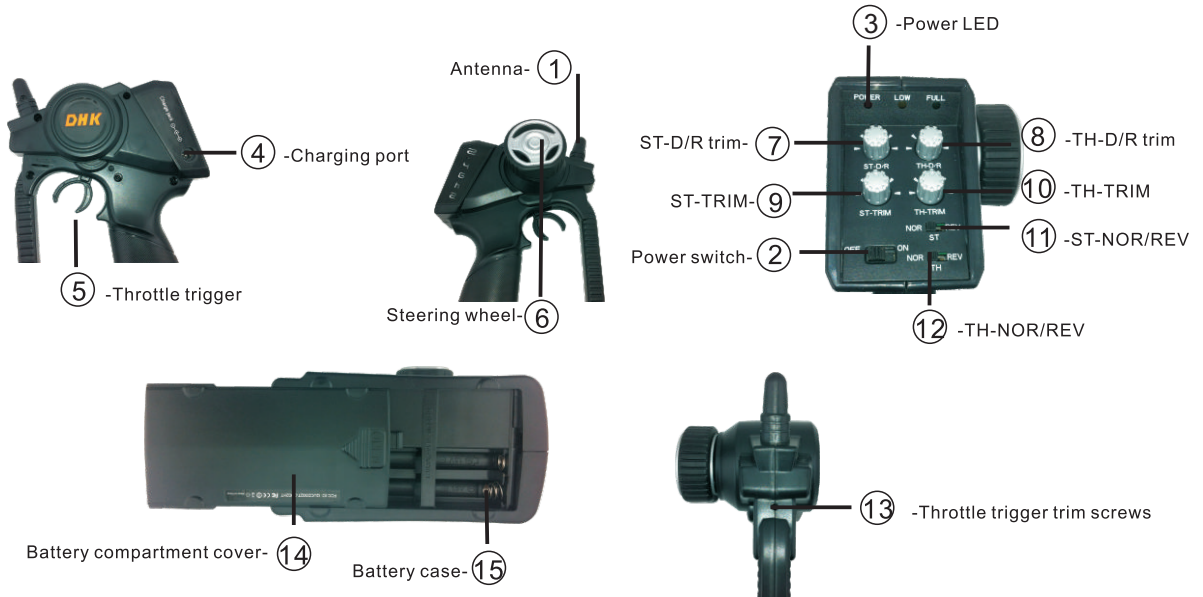

Receiver Functions



Frequency range	: 2.4GHz
2.4GHz modulation	: AFHDS
Sensitivity	: -100dbm
Working voltage	: DC4.8-6.0V
Working current	: ≤25mA
Size	: 5.7*26*15.2mm
Weight	: 11.2g

1. Antenna: Pull out the antenna completely

2. Connecting ports: receiver power port and channel signal connecting ports

> ST/1: Channel 1, steering signal port

> TH/2: Channel 2, throttle servo or ESC signal port

> AUX/3: Auxiliary signal port

> BATT/4: Receiver power port, can be auxiliary signal port

3. Set keys & LED indicators

>**Bind setup.** Switch on the receiver, indicators flash slowly, press the setup key for 2 seconds and release it, LED indicator flash in faster motion, binding starts. When the LED indicator is on in stable status, the binding is complete. Note: To bind it quickly and effectively, please put the receiver 40-50cm away from the transmitter.

>**Failsafe.** Switch on the transmitter and receiver, then you can see the LED indicator on receiver is on. Adjust the throttle servo or ESC to brake or stop status, and keep it that way. Press the setup key, then receiver LED indicator flashes, keep this for 3 seconds. After this, release the setup key. Failsafe setup is complete.

>**Disabling failsafe function.** Switch on transmitter and receiver, once the signal is connected, LED indicator is on. Press the setup key for 2 seconds, LED indicator flashes quickly, at this point, keep pressing the setup key without release, press it for 2 more seconds, LED indicator flashes slowly. Release the setup key, LED indicator is on. The setup is complete.

PART II:

2.4GHz Transmitter (LCD Version, Model#: D302HT)

Safety Precautions

Please refer to Safety Precautions in PART I

Transmitter Specifications

Please refer to Transmitter Specifications in PART I.

2.4GHz LCD Transmitter Parts and Functions

1. 2.4G transmitter antenna: before use, please pull the antenna straight up.
2. Power switch: Press down to turn on the transmitter, press the switch again to turn it off.
3. LCD display: shows transmitter menus, parameters and operation instructions.
4. Charging port: charging area is positive inside and negative outside. When Ni-Mh or Ni-Cd rechargeable batteries are to be charged, right charger should be selected for re-charging the batteries.
5. Throttle trigger: drag, push or make the throttle trigger to a neutral position to forward, reverse or brake your RC model.
6. Steering wheel: turn the steering wheel counterclockwise to turn the model to left. Turn the steering wheel clockwise to turn the model to right. Release it to neutral for straight driving.
7. Menu keys: Press Left key (<) or Right key (>), move the cursor to LCD display options.
8. DATA change keys: press Left key (+) or Right key (-) to change, adjust and save current parameters.
9. Throttle trigger set screw: use a 2.5mm hex screw driver to move forward or backward to adjust the throttle trigger to a comfortable hand feeling.
10. Battery compartment cover: Press the door to OPEN indicated direction to open the battery compartment cover. Snap the compartment door into the slot to close the battery compartment.
11. Installing batteries: open the battery compartment cover, install 4 pcs "AA" batteries (same type) according to the indicated "+" "-" orientations. Turn on the transmitter and check the indicator status for a solid green light. Please take out the batteries when the transmitter is not in use. If the status LED flashes red, the transmitter batteries may be weak, discharged or possibly installed incorrectly. Replace with new or freshly charged batteries. The power indicator light does not indicate the charge level of the battery pack installed in the model.

Parts Diagrams

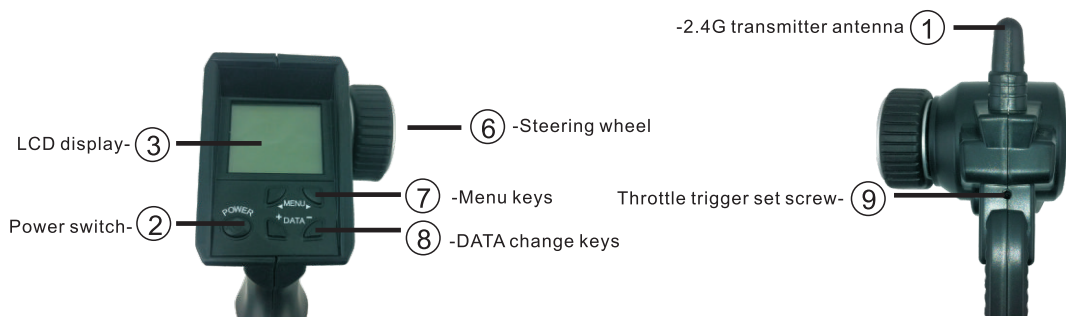

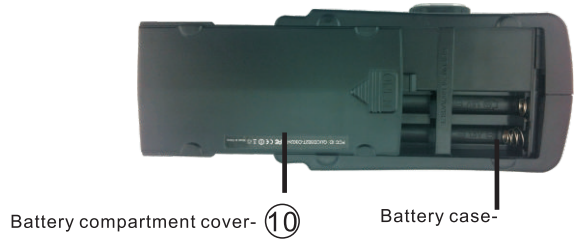

LCD Functions and Operations

Key Operations

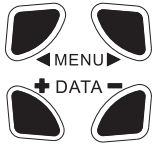

Menu keys:

Press Left key (<) to main command, and Right key (>) for secondary command.

DATA keys:

Press Left key (+) or Right key (-) to adjust, set up and auto save the current chosen function.

Display Interface



Switch on the transmitter, you will hear “beep” sound (beeps once), and the LCD display mode will read the default parameters pre-set at the factory and BATT status mode (main menu).

BATT: battery status, function reset settings

Battery level display. Battery voltage appears on LCD display. When the voltage is 4.4V, the value flashes and you can hear warning sound. This means the battery voltage is deficient. When battery voltage value shows 4.0V, the value blinks fast and warning sound keeps strong. This indicates battery voltage is too low and batteries cannot be used. Please turn off the transmitter and replace batteries. If rechargeable Ni-Mh or Ni-Cd batteries are used, please charge the batteries with proper charger.

Function reposition. In case the parameters are messed up or if you don't know how to set up, please turn off the power, press and hold MENU Left key (<). Then turn on the power and you will hear “beep” sound after two seconds. Release all keys and all parameters will go back to factory default values.

Frequency duplication setting. When two transmitters are used at the same time, a frequency might be duplicated. In this case, you may choose the auto frequency function. First turn off the power, then press and hold MENU Right key (>), and turn on the power. The display will show hopping data. Release the key and the hopping data will stop. The digit shown on the display is your frequency. Bind the transmitter with the receiver through binding keys.

MOD: Setting up mode and naming

15 group memory data for choice, it's easy to manage and use. At start status, press Left key (+) or Right key (-) of the DATA to choose the necessary module (Screen shows main menu)

For easy control, you may name each module. Press Left key (<) on MENU (6 times on Main Menu) until you see 000 01 on the screen and the first digit must flash, at this moment, you may change the data here. Press Left key (+) or Right key (-) to choose necessary data. Once first change is made, press Right key (>) on MENU to move the cursor to the next position, then press Left key (-) or Right key (+) to choose the needed data. Based on the above, you can change data for the 3rd data group. Once all is changed, press Left key (<) on the MENU function to get back to Main Menu and save the setup. (Screen shows 000 01).

MOD	Range	Default
MODULE	0 – 15	01
NAMING UNITS	Digits 0-9, letters A-Z	000

REV: Servo forward and reverse setup



Setting up Steering servo direction. Press MENU function Left key (<) or Right key (>) (Press once under MAIN MENU) until you see " ***REV-ST", then press DATA function Left key (+) or Right key (-) to choose ON/OFF. (Screen shows OFF REV-ST).



Setting up Throttle speed neutral position. Press MENU function Left key (<) (Press once under the MAIN MENU) and then press twice of MENU Right key (>) until you see ***REV-TH. Press DATA function Left key (+) or Right key (-) ON/OFF. (Screen shows OFF REV-TH).

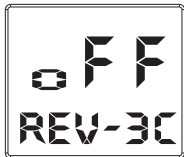

Setting up the 3rd Channel: Press MENU function Left key (<) (Press once under MAIN MENU), then press twice on Menu function Right key (>) until you see ***REV-3C, press DATA function Left key (+) or Right key (-) to choose ON/OFF. (Screen shows OFF REV-3C).

REV	Initial value	Range
ST	OFF	ON/OFF
TH	OFF	ON/OFF
3C	OFF	ON/OFF

TRM: Servo neutral trim setup

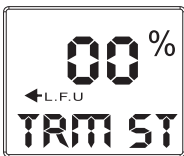

Setting up steering servo(ST) neutral position parameters. Press MENU function Left key (<) (Press twice under MAIN MENU) until you see **% TRM ST and neutral value. Press DATA function Left key (+) or Right key (-) to change the steering neutral position. On the screen there is steering neutral status L.F. U, R. B. D and percentage values indicating the neutral position at that setup. (Screen shows 00% TRM ST).

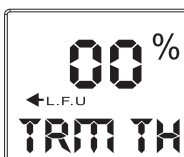

Setting up throttle speed (TH) neutral position parameters. Press MENU function Left key (<) (Press twice under MAIN MENU), and press MENU function Right key (<) until you see **% TRM TH and neutral value. At this point, press DATA function Left key (+) or Right key (-) for adjustment. On the screen you will see neutral position status indicator L. F. U, R. B. D and percentage values. (Screen shows 00% TRM TH)

TRM	Initial value	Range
ST	0%	100%<--L. F. U—100% R.B.D.-->
TH	0%	100%<--L. F. U—100% R.B.D.-->

D/R: Servo angle adjustment setup



Set up Steering servo (ST) angle. Press Menu function Left key (<) (Press 3 times on MAIN MENU) until you see **% D/R ST on the screen, then press DATA function Left key (+) or Right key (-) to choose servo angle parameter. (Screen shows 100% D/R ST).



Set up Throttle servo (TH) forward and reverse angle. Press MENU function Left key (<) (Press 3 times on MAIN MENU), then press MENU function Right key (>) once, the screen shows **% D/R TH, press DATA function Left key (+) or Right key (-) for throttle angle parameters. (Screen shows 100% D/R TH)

D/R	Initial value	Range
ST	100%	0% - 100%
TH	100%	0% - 100%

EPA: End point adjustment (servo single side angle setup)

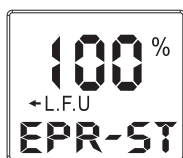

Set up steering servo single side (left steering or right steering) travel angle. Press MENU function Left key (<) (Press 4 times under MAIN MENU) until the screen shows **% EPA ST. Turn the steering wheel clockwise, the screen shows the EPA value of right steering R.B.D.-->; Press DATA function Left key (+) or Right key (-) and change the data. When you turn the steering wheel counterclockwise, the screen displays the EPA value of left steering L. F. U on steering servo. Press DATA function Left key (+) or Right key (-) for desired value. (Screen shows 100% EPA-ST)



Note: for this function, the steering servo travel angle is adjusted to a wider or narrower range, hence the steering angle of the left or right tire is adjusted to desired angle.

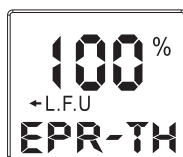

Set up throttle speed (forward or reverse). Press MENU function Left key (<) (Press 4 times under MAIN MENU) and press once on MENU function Right key (>), the screen shows **% EPA TH. Pull back the throttle trigger and the screen displays L.F.U value of forward (F) speed. Press DATA function Left key (+) or Right key (-) to change the value. Push forward the throttle trigger and the screen shows reverse R.B.D value of reverse speed, press DATA function Left key (+) or Right key (-) to change the value. (Screen shows 100% EPA-ST)



Note: for this function, the throttle servo angle is adjusted (wider or narrower) on nitro- (gas-) powered vehicles, and for EP vehicles, speed of the electronic speed controller adjusted (faster or slower).

EPA	Initial value	Range
ST←L.F.U	100%	0% - 120%
ST R.B.D→	100%	0% - 120%
TH←L.F.U	100%	0% - 120%
TH R.B.D→	100%	0% - 120%

ABS: Setting up brake system



Set up throttle ABS brake system. Press MENU function Left key (<) (Press 5 times under MAIN MENU), screen shows *** ABS- TH, press DATA function Left key (+) or Right key (-) to choose ON/OFF. At ON status, it prevents the tires from getting stuck in powerful gripping motion during brake. (Screen shows *** ABS- TH)

For each of the above setup, when one setting is selected, please wait for 5 seconds until you see the main menu, then that setting is automatically saved as memory.

Receiver Functions

Please refer to Receiver Functions Section in PART I.

FCC Caution: Any changes or modifications not expressly approved by the party responsible for compliance could void the user's authority to operate this equipment. This device complies with Part 15 of the FCC Rules. Operation is subject to two conditions: (1) This device may not cause harmful interference, and (2) This device must accept any interference received, including interference that may cause undesired operation.

This device and its antenna(s) must not be co-located or operating in conjunction with any other antenna or transmitter.

TCB

GRANT OF EQUIPMENT AUTHORIZATION

TCB

Certification
Issued Under the Authority of the
Federal Communications Commission
By:

PHOENIX TESTLAB GmbH
Koenigswinkel 10
D-32825 Blomberg,
Germany

Date of Grant: 11/20/2012
Application Dated: 11/20/2012

DHK HOBBY
E2 BLDG, WANFENG WESTERN IND ZONE, HEYI, SHAJING
SHENZHEN, 518104
China

Attention: Jack Jiang , Manger

NOT TRANSFERABLE
EQUIPMENT AUTHORIZATION IS HEREBY ISSUED TO THE NAMED GRANTEE, AND IS
VALID ONLY FOR THE EQUIPMENT IDENTIFIED HEREON FOR USE UNDER THE COMMISSION'S
RULES AND REGULATIONS LISTED BELOW.

FCC IDENTIFIER: QUCD302T-D302HT
Name of Grantee: DHK HOBBY
Equipment Class: Part 15 Low Power Communication Device
Transmitter
Notes: 2.4GHz Transmitter

Table with 5 columns: Grant Notes, FCC Rule Parts, Frequency Range (MHZ), Output Watts, Frequency Tolerance, Emission Designator. Row 1: 15C, 2402.0 - 2474.0

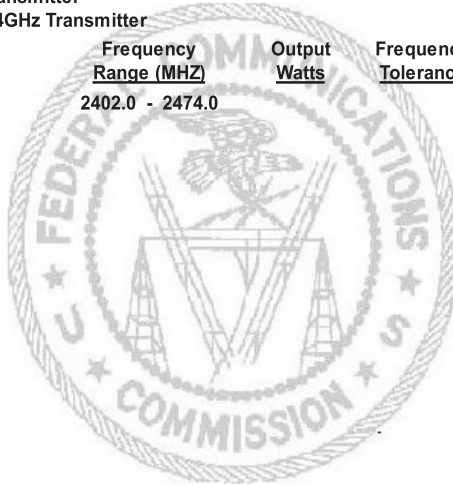

DHK HOBBY
http://www.dhkhobby.com

